

SHARP®

DATA PROJECTOR MODEL **PG-D40W3D**

OPERATION MANUAL

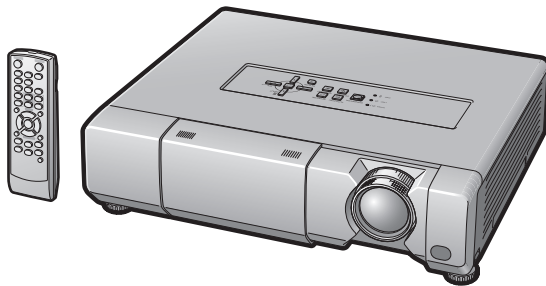

Introduction

Quick Start

Setup

Connections

Basic
Operation

Useful
Features

Appendix



IMPORTANT

- For your assistance in reporting the loss or theft of your Projector, please record the Model and Serial Number located on the bottom of the projector and retain this information.
- Before recycling the packaging, please ensure that you have checked the contents of the carton thoroughly against the list of “Supplied accessories” on page **11**.

Model No.:

Serial No.:

SPECIAL NOTE FOR USERS IN THE U.K.

The mains lead of this product is fitted with a non-rewireable (moulded) plug incorporating a 10A fuse. Should the fuse need to be replaced, a BSI or ASTA approved BS 1362 fuse marked  or  and of the same rating as above, which is also indicated on the pin face of the plug, must be used.

Always refit the fuse cover after replacing the fuse. Never use the plug without the fuse cover fitted.

In the unlikely event of the socket outlet in your home not being compatible with the plug supplied, cut off the mains plug and fit an appropriate type.

DANGER:

The fuse from the cut-off plug should be removed and the cut-off plug destroyed immediately and disposed of in a safe manner.

Under no circumstances should the cut-off plug be inserted elsewhere into a 13A socket outlet, as a serious electric shock may occur.

To fit an appropriate plug to the mains lead, follow the instructions below:

WARNING:

THIS APPARATUS MUST BE EARTHED.

IMPORTANT:

The wires in this mains lead are coloured in accordance with the following code:

Green-and-yellow	: Earth
Blue	: Neutral
Brown	: Live

As the colours of the wires in the mains lead of this apparatus may not correspond with the coloured markings identifying the terminals in your plug proceed as follows:

- The wire which is coloured green-and-yellow must be connected to the terminal in the plug which is marked by the letter E or by the safety earth symbol  or coloured green or green-and-yellow.
- The wire which is coloured blue must be connected to the terminal which is marked with the letter N or coloured black.
- The wire which is coloured brown must be connected to the terminal which is marked with the letter L or coloured red.

IF YOU HAVE ANY DOUBT, CONSULT A QUALIFIED ELECTRICIAN.

Authorized representative responsible for the European Union Community Market

SHARP ELECTRONICS (Europe) GmbH
Sonninstraße 3, D-20097 Hamburg

E.U. ONLY

The supplied CD-ROM contains operation instructions in English, German, French, Spanish, Italian, Dutch, Swedish, Portuguese and Chinese. Carefully read through the operation instructions before operating the projector.

Die mitgelieferte CD-ROM enthält Bedienungsanleitungen in Englisch, Deutsch, Französisch, Spanisch, Italienisch, Niederländisch, Schwedisch, Portugiesisch und Chinesisch. Bitte lesen Sie die Bedienungsanleitung vor der Verwendung des Projektors sorgfältig durch.

Le CD-ROM fourni contient les instructions de fonctionnement en anglais, allemand, français, espagnol, italien, néerlandais, suédois, portugais et chinois. Veuillez lire attentivement ces instructions avant de faire fonctionner le projecteur.

El CD-ROM suministrado contiene instrucciones de operación en inglés, alemán, francés, español, italiano, holandés, sueco, portugués y chino. Lea cuidadosamente las instrucciones de operación antes de utilizar el proyector.

Il CD-ROM in dotazione contiene istruzioni per l'uso in inglese, tedesco, francese, spagnolo, italiano, olandese, svedese, portoghese e cinese. Leggere attentamente le istruzioni per l'uso prima di usare il proiettore.

De meegeleverde CD-ROM bevat handleidingen in het Engels, Duits, Frans, Spaans, Italiaans, Nederlands, Zweeds, Portugees en Chinees. Lees de handleiding zorgvuldig door voor u de projector in gebruik neemt.

Den medföljande CD-ROM-skivan innehåller bruksanvisningar på engelska, tyska, franska, spanska, italienska, holländska, svenska, portugisiska och kinesiska. Läs noga igenom bruksanvisningen innan projektorn tas i bruk.

O CD-ROM fornecido contém instruções de operação em Inglês, Alemão, Francês, Espanhol, Italiano, Holandês, Sueco, Português e Chinês. Leia cuidadosamente todas as instruções de operação antes de operar o projetor.

附送之CD-ROM光碟中，有用英文、德文、法文、西班牙文、意大利文、荷蘭文、瑞典文、葡萄牙文和中文所寫的使用說明書。在操作本投影機之前，請務必仔細閱讀整本使用說明書。

Before using the projector, please read this operation manual carefully.

Introduction

ENGLISH

There are two important reasons for prompt warranty registration of your new SHARP Projector, using the REGISTRATION CARD packed with the projector.

1. WARRANTY

This is to assure that you immediately receive the full benefit of the parts, service and labor warranty applicable to your purchase.

2. CONSUMER PRODUCT SAFETY ACT

To ensure that you will promptly receive any safety notification of inspection, modification, or recall that SHARP may be required to give under the 1972 Consumer Product Safety Act, PLEASE READ CAREFULLY THE IMPORTANT "LIMITED WARRANTY" CLAUSE.

U.S.A. ONLY

WARNING: High brightness light source. Do not stare into the beam of light, or view directly. Be especially careful that children do not stare directly into the beam of light.



WARNING: To reduce the risk of fire or electric shock, do not expose this product to rain or moisture.

See bottom of projector.

	CAUTION RISK OF ELECTRIC SHOCK. DO NOT REMOVE SCREWS EXCEPT SPECIFIED USER SERVICE SCREW.	
CAUTION: TO REDUCE THE RISK OF ELECTRIC SHOCK, DO NOT REMOVE COVER. NO USER-SERVICEABLE PARTS EXCEPT LAMP UNIT. REFER SERVICING TO QUALIFIED SERVICE PERSONNEL.		



The lightning flash with arrowhead symbol, within an equilateral triangle, is intended to alert the user to the presence of uninsulated "dangerous voltage" within the product's enclosure that may be of sufficient magnitude to constitute a risk or electric shock to persons.



The exclamation point within a triangle is intended to alert the user to the presence of important operating and maintenance (servicing) instructions in the literature accompanying the product.

WARNING:

This is a Class A product. In a domestic environment this product may cause radio interference in which case the user may be required to take adequate measures.

WARNING: FCC Regulations state that any unauthorized changes or modifications to this equipment not expressly approved by the manufacturer could void the user's authority to operate this equipment.

U.S.A. ONLY

The enclosed computer cable must be used with the device. The cable is provided to ensure that the device complies with FCC Class A verification.

U.S.A. ONLY

INFORMATION

This equipment has been tested and found to comply with the limits for a Class A digital device, pursuant to Part 15 of the FCC Rules. These limits are designed to provide reasonable protection against harmful interference when the equipment is operated in a commercial environment. This equipment generates, uses, and can radiate radio frequency energy and, if not installed and used in accordance with the operation manual, may cause harmful interference to radio communications. Operation of this equipment in a residential area is likely to cause harmful interference, in which case the user will be required to correct the interference at his own expense.

U.S.A. ONLY

PRODUCT DISPOSAL

This product utilizes tin-lead solder, and lamp containing a small amount of mercury. Disposal of these materials may be regulated due to environmental considerations. For disposal or recycling information, please contact your local authorities, the Electronics Industries Alliance: www.eiae.org, the lamp recycling organization www.lamprecycle.org, or Sharp at 1-800-BE-SHARP.

U.S.A. ONLY

Caution Concerning Lamp Replacement

- This projector utilizes a pressurized mercury lamp. A loud sound may indicate lamp failure. Lamp failure can be attributed to numerous sources such as: excessive shock, improper cooling, surface scratches or deterioration of the lamp due to a lapse of usage time.
The period of time up to failure largely varies depending on the individual lamp and/or the condition and the frequency of use. It is important to note that failure can often result in the bulb cracking.
- When the lamp replacement indicator and on-screen display icon are illuminated, it is recommended that the lamp be replaced with a new one immediately, even if the lamp appears to be operating normally.
- Should the lamp break, there is also a possibility that glass particles may spread inside of the projector. In such a case, it is recommended you contact your nearest Sharp Authorized Projector Dealer or Service Center to assure safe operation.
- Should the lamp break, the glass particles may spread inside the lamp cage or gas contained in the lamp may be vented into the room from the exhaust vent. Because the gas in this lamp includes mercury, ventilate the room well if the lamp breaks and avoid all exposure to the released gas. In case of exposure to the gas, consult a doctor as soon as possible.



Caution

- Do not remove the lamp unit from the projector right after use. The lamp will be very hot and may cause burns or injury.
- Wait at least one hour after the power cord is disconnected to allow the surface of the lamp unit to fully cool before removing the lamp unit.
- Do not touch the glass surface of the lamp unit or the inside of the projector.
- Do not loosen other screws except for the lamp unit cover and lamp unit.
- Make sure to reset the lamp timer only when replacing the lamp. If you reset the lamp timer and continue to use the same lamp, this may cause the lamp to become damaged or explode.

- **Carefully change the lamp by following the instructions described on pages 55 to 57.**

*** If you wish, you may have the lamp replaced at your nearest Sharp Authorized Projector Dealer or Service Center.**

* If the new lamp does not light after replacement, take your projector to the nearest Sharp Authorized Projector Dealer or Service Center for repair.

How to Read this Operation Manual

- The specifications are slightly different, depending on the model. However, you can connect and operate all models in the same manner.
- In this operation manual, the illustration and the screen display are simplified for explanation, and may differ slightly from the actual display.

Using the Menu Screen

Buttons used in this operation

Menu Selections (Adjustments)

Example: Adjusting "Bright".

- This operation can also be performed by using the buttons on the projector.

- 1 Press **MENU/HELP**.
• The "Picture" menu screen for the selected input mode is displayed.
- 2 Press **▶** or **◀** and select "Picture" to adjust.

Example: "Picture" screen menu for COMPUTER (RGB) input

Menu item		1	
Picture	SCR	PRJ	Net
Picture Mode		Standard	
Contrast	0		
Bright	0		
Red	0		
Blue	0		
CLR Temp	0		
BrilliantColor™	1		
C.M.S. Setting		On	
C.M.S.		Off	
DNR		Off	
Eco+Quiet		On	
◆◆Reset			
SEL./ADJ.	ENTER	END	

Button used in this step

On-screen display

38

InfoIndicates safeguards for using the projector.

Note Indicates additional information for setting up and operating the projector.

For Future Reference

Maintenance

➔ P. 52

Troubleshooting

➔ PP. 59 and 60

Index

➔ P. 64

Contents

Preparing

Introduction

How to Read this Operation Manual	3
Contents	4
IMPORTANT SAFEGUARDS	6
How to Access the PDF Operation Manuals	10
Accessories	11
Part Names and Functions	12
Projector	12
Rear View	13
Inserting the Batteries	15
Usable Range	15

Quick Start

Quick Start	16
Setup and Projection	16

Setup

Setting up the Projector	18
Video Setup	18
Setting up the Projector	18
Standard Setup (Front Projection)	18
Ceiling-mount Setup	18
Projection (PRJ) Mode	19
Screen Size and Projection Distance	20

Connections

Connecting the Projector to Other Equipment	21
Controlling the Projector by a Computer	24
Connecting the Power Cord	25

Using

Basic Operation

Turning the Projector On/Off	26
Turning the Projector On	26
Turning the Power Off (Putting the Projector into Standby Mode)	26
Image Projection	27
Adjusting the Projected Image	27
Correcting Trapezoidal Distortion	28
Switching the Input Mode	29
Adjusting the Volume	29
Displaying the Black Screen and Turning Off the Sound Temporarily	29
Resize Mode	30

Useful Features

Operating with the Remote Control	32
Displaying and Setting the Break Timer	32
Displaying the Pointer	32
Using the Spot Function	32
Switching the Eco+Quiet Mode	32
Auto Sync (Auto Sync Adjustment)	33
Freezing a Moving Image	33
Selecting the Picture Mode	33
Displaying an Enlarged Portion of an Image	33
Using the Remote Control as the Wireless Computer Mouse	34
Menu Items	35
Using the Menu Screen	38
Menu Selections (Adjustments)	38
Picture Adjustment (“Picture” Menu)	40
Selecting the Picture Mode	40
Adjusting the Image	41
Adjusting the Color Temperature	41
Adjusting the Colors	41
Progressive	42
Reducing Image Noise (DNR)	42
Eco+Quiet	42
Adjusting the Projected Image (“SCR - ADJ” Menu)	43
Setting the Resize Mode	43
Adjusting the Image Position	43
Keystone Correction	43
Setting the Overscan	43
Setting the On-screen Display	43
Closed Caption	44
Selecting the Background Image	44
Reversing/Inverting Projected Images	44
DLP® Link™	44
DLP® Link™ Invert	44
Setting the Video Setup	44
Selecting the On-screen Display Language	44
Adjusting the Projector Function (“PRJ - ADJ” Menu)	45
Auto Sync (Auto Sync Adjustment)	45
Auto Power Off Function	45
Auto Restart Function	45
STANDBY Mode	45
Setting the Confirmation Sound (System Sound)	45
Audio Output Type Setting	46
Speaker Setting	46
Audio Input	46
Selecting the Transmission Speed (RS-232C)	46
Fan Mode Setting	46
System Lock Function	46

Checking the Lamp Life Status.....	47
Keylock Function	48
Setting up the Projector Network	
Environment (“Network” Menu).....	49
Setting a Password	49
DHCP Client Setting	50
TCP/IP Setting.....	50
Confirming the Projector Information.....	50
Troubleshooting with the	
“Help” Menu.....	51
Utilizing the “Help” Menu Functions	51

Reference

Appendix

Maintenance.....	52
Maintenance Indicators	53
Regarding the Lamp.....	55
Lamp.....	55
Caution Concerning the Lamp.....	55
Replacing the Lamp	55
Removing and Installing the	
Lamp Unit.....	56
Resetting the Lamp Timer	57
Computer Compatibility Chart	58
Troubleshooting.....	59
For SHARP Assistance.....	61
Specifications.....	62
Dimensions.....	63
Index.....	64

IMPORTANT SAFEGUARDS

CAUTION: Please read all of these instructions before you operate this product and save these instructions for later use.

Electrical energy can perform many useful functions. This product has been engineered and manufactured to assure your personal safety. BUT IMPROPER USE CAN RESULT IN POTENTIAL ELECTRICAL SHOCK OR FIRE HAZARDS. In order not to defeat the safeguards incorporated in this product, observe the following basic rules for its installation, use and servicing.

1. Read Instructions

All the safety and operating instructions should be read before the product is operated.

2. Retain Instructions

The safety and operating instructions should be retained for future reference.

3. Heed Warnings

All warnings on the product and in the operating instructions should be adhered to.

4. Follow Instructions

All operating and use instructions should be followed.

5. Cleaning

Unplug this product from the wall outlet before cleaning. Do not use liquid cleaners or aerosol cleaners. Use a damp cloth for cleaning.

6. Attachments

Do not use attachments not recommended by the product manufacturer as they may cause hazards.

7. Water and Moisture

Do not use this product near water—for example, near a bath tub, wash bowl, kitchen sink, or laundry tub; in a wet basement; or near a swimming pool; and the like.

8. Accessories

Do not place this product on an unstable cart, stand, tripod, bracket, or table. The product may fall, causing serious injury to a child or adult, and serious damage to the product. Use only with a cart, stand, tripod, bracket, or table recommended by the manufacturer, or sold with the product. Any mounting of the product should follow the manufacturer's instructions, and should use a mounting accessory recommended by the manufacturer.

9. Transportation

A product and cart combination should be moved with care. Quick stops, excessive force, and uneven surfaces may cause the product and cart combination to overturn.



10. Ventilation

Slots and openings in the cabinet are provided for ventilation to ensure reliable operation of the product and to protect it from overheating, and these openings must not be blocked or covered. The openings should never be blocked by placing the product on a bed, sofa, rug, or other similar surface. This product should not be placed in a built-in installation such as a bookcase or rack unless proper ventilation is provided or the manufacturer's instructions have been adhered to.

11. Power Sources

This product should be operated only from the type of power source indicated on the marking label. If you are not sure of the type of power supply to your home, consult your product dealer or local power company. For products intended to operate from battery power, or other sources, refer to the operating instructions.

12. Grounding or Polarization

This product is provided with one of the following types of plugs. If the plug should fail to fit into the power outlet, please contact your electrician.

Do not defeat the safety purpose of the plug.

- Two-wire type (mains) plug.
- Three-wire grounding type (mains) plug with a grounding terminal.
This plug will only fit into a grounding type power outlet.

13. Power-Cord Protection

Power-supply cords should be routed so that they are not likely to be walked on or pinched by items placed upon or against them, paying particular attention to cords at plugs, convenience receptacles, and the point where they exit from the product.

14. Lightning

For added protection for this product during a lightning storm, or when it is left unattended and unused for long periods of time, unplug it from the wall outlet and disconnect the cable system. This will prevent damage to the product due to lightning and power-line surges.

15. Overloading

Do not overload wall outlets, extension cords, or integral convenience receptacles as this can result in a risk of fire or electric shock.

16. Object and Liquid Entry

Never push objects of any kind into this product through openings as they may touch dangerous voltage points or short-out parts that could result in a fire or electric shock. Never spill liquid of any kind on the product.

17. Servicing

Do not attempt to service this product yourself as opening or removing covers may expose you to dangerous voltage or other hazards. Refer all servicing to qualified service personnel.

18. Damage Requiring Service

Unplug this product from the wall outlet and refer servicing to qualified service personnel under the following conditions:

- When the power-supply cord or plug is damaged.
- If liquid has been spilled, or objects have fallen into the product.
- If the product has been exposed to rain or water.
- If the product does not operate normally by following the operating instructions. Adjust only those controls that are covered by the operating instructions, as an improper adjustment of other controls may result in damage and will often require extensive work by a qualified technician to restore the product to normal operation.

- If the product has been dropped or damaged in any way.
- When the product exhibits a distinct change in performance, this indicates a need for service.

19. Replacement Parts

When replacement parts are required, be sure the service technician has used replacement parts specified by the manufacturer or have the same characteristics as the original part. Unauthorized substitutions may result in fire, electric shock, or other hazards.

20. Safety Check

Upon completion of any service or repairs to this product, ask the service technician to perform safety checks to determine that the product is in proper operating condition.

21. Wall or Ceiling Mounting

This product should be mounted to a wall or ceiling only as recommended by the manufacturer.

22. Heat

This product should be situated away from heat sources such as radiators, heat registers, stoves, or other products (including amplifiers) that produce heat.

- DLP® and the DLP logo are registered trademarks of Texas Instruments and BrilliantColor™ and DLP® Link™ are trademarks of Texas Instruments.
- Microsoft® and Windows® are registered trademarks of Microsoft Corporation in the United States and/or other countries.
- PC/AT is a registered trademark of International Business Machines Corporation in the United States.
- Adobe® Reader® is a trademark of Adobe Systems Incorporated.
- Macintosh® is a registered trademark of Apple Computer, Inc. in the United States and/or other countries.
- HDMI, the HDMI logo and High-Definition Multimedia Interface are trademarks or registered trademarks of HDMI Licensing LLC.
- PJLink is a registered trademark or an application trademark in Japan, the United States, Canada, E.U., China and/or other countries/regions.
- All other company or product names are trademarks or registered trademarks of their respective companies.
- Some IC chips in this product include confidential and/or trade secret property belonging to Texas Instruments. Therefore you may not copy, modify, adapt, translate, distribute, reverse engineer, reverse assemble or discompile the contents thereof.

Observe the following safeguards when setting up your projector.

Caution concerning the lamp unit

- Potential hazard of glass particles if lamp ruptures. In case of lamp rupture, contact your nearest Sharp Authorized Projector Dealer or Service Center for replacement. See “Regarding the Lamp” on page 55.



Caution concerning the setup of the projector

- For minimal servicing and to maintain high image quality, SHARP recommends that this projector be installed in an area free from humidity, dust and cigarette smoke. When the projector is subjected to these environments, the vents and lens must be cleaned more often. As long as the projector is regularly cleaned, use in these environments will not reduce the overall operation life of the unit. Internal cleaning should only be performed by a Sharp Authorized Projector Dealer or Service Center.

Rest your eyes occasionally.

- Continuously watching the screen for long hours will cause eye strain. Take regular breaks to rest your eyes.

Do not set up the projector in places exposed to direct sunlight or bright light.

- Position the screen so that it is not in direct sunlight or room light. Light falling directly on the screen washes out the colors, making viewing difficult. Close the curtains and dim the lights when setting up the screen in a sunny or bright room.

Caution regarding placing of the projector

- Place the projector on a level site within the adjustment range (9 degrees) of the adjustment foot.

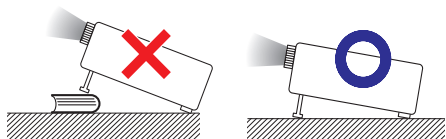

- After the projector is purchased, a faint smell from the vent may appear when the power is first turned on. This is normal and is not a malfunction. It will disappear after the projector is used for a while.

When using the projector in high-altitude areas such as mountains (at altitudes of approximately 1,500 meters (4,900 feet) or more)

- When you use the projector in high-altitude areas with thin air, set “Fan Mode” to “High”. Neglecting this can affect the longevity of the optical system.
- Use the projector at altitudes of 2,300 meters (7,500 feet) or less.

Warning about placing the projector in a high position

- When placing the projector in a high position, make certain it is carefully secure to avoid personal injury caused by the projector falling down.

Do not subject the projector to hard impact and/or vibration.

- Protect the lens so as not to hit or damage the surface of the lens.

Avoid locations with extremes of temperature.

- The operating temperature of the projector is from 41°F to 95°F (+5°C to +35°C).
- The storage temperature of the projector is from -4°F to 140°F (-20°C to +60°C).

Do not block the exhaust and intake vents.

- Allow at least 11 ¹³/₁₆ inches (30 cm) of space between the exhaust vent and the nearest wall or obstruction.
- Ensure that the intake vent and the exhaust vent are not obstructed.
- If the cooling fan becomes obstructed, a protection circuit will automatically put the projector into standby mode to prevent overheat damage. This does not indicate a malfunction. (See pages 53 and 54.) Remove the projector power cord from the wall outlet and wait at least 10 minutes. Place the projector where the intake and exhaust vents are not blocked, plug the power cord back in and turn on the projector. This will return the projector to the normal operating condition.

Caution regarding usage of the projector

- If you are not to use the projector for a long time or before moving the projector, make certain you unplug the power cord from the wall outlet, and disconnect any other cables connected to it.
- Do not carry the projector by holding the lens.
- When storing the projector, ensure that you close the lens shutter.
- Do not expose the projector to direct sunlight or place next to heat sources. Doing so may affect the cabinet color or cause deformation of the plastic cover.

Other connected equipment

- When connecting a computer or other audio-visual equipment to the projector, make the connections AFTER unplugging the power cord of the projector from the AC outlet and turning off the equipment to be connected.
- Please read the operation manuals of the projector and the equipment to be connected for instructions on how to make the connections.

Using the projector in other countries

- The power supply voltage and the shape of the plug may vary depending on the region or country you are using the projector in. When using the projector overseas, make sure you use an appropriate power cord for the country you are in.

Temperature monitor function



- If the temperature inside the projector increases, due to blockage of the air vents, or the setting location, the temperature warning indicator will blink. And if the temperature keeps on rising, “ TEMP.” will illuminate in the lower left corner of the picture with the temperature warning indicator blinking. If this state continues, the lamp will turn off, the cooling fan will run and then the projector will enter standby mode. Refer to “Maintenance Indicators” on pages 53 and 54 for details.

Info

- The cooling fan regulates the internal temperature, and its performance is automatically controlled. The sound of the fan may change during projector operation due to changes in the fan speed. This does not indicate malfunction.

Closed Caption uses Bitstream Vera fonts

Copyright (c) 2003 by Bitstream, Inc. All Rights Reserved. Bitstream Vera is a trademark of Bitstream, Inc. Permission is hereby granted, free of charge, to any person obtaining a copy of the fonts accompanying this license (“Fonts”) and associated documentation files (the “Font Software”), to reproduce and distribute the Font Software, including without limitation the rights to use, copy, merge, publish, distribute, and/or sell copies of the Font Software, and to permit persons to whom the Font Software is furnished to do so, subject to the following conditions:

The above copyright and trademark notices and this permission notice shall be included in all copies of one or more of the Font Software typefaces.

The Font Software may be modified, altered, or added to, and in particular the designs of glyphs or characters in the Fonts may be modified and additional glyphs or characters may be added to the Fonts, only if the fonts are renamed to names not containing either the words “Bitstream” or the word “Vera”.

This License becomes null and void to the extent applicable to Fonts or Font Software that has been modified and is distributed under the “Bitstream Vera” names.

The Font Software may be sold as part of a larger software package but no copy of one or more of the Font Software typefaces may be sold by itself.

THE FONT SOFTWARE IS PROVIDED “AS IS”, WITHOUT WARRANTY OF ANY KIND, EXPRESS OR IMPLIED, INCLUDING BUT NOT LIMITED TO ANY WARRANTIES OF MERCHANTABILITY, FITNESS FOR A PARTICULAR PURPOSE AND NONINFRINGEMENT OF COPYRIGHT, PATENT, TRADEMARK, OR OTHER RIGHT. IN NO EVENT SHALL BITSTREAM OR THE GNOME FOUNDATION BE LIABLE FOR ANY CLAIM, DAMAGES OR OTHER LIABILITY, INCLUDING ANY GENERAL, SPECIAL, INDIRECT, INCIDENTAL, OR CONSEQUENTIAL DAMAGES, WHETHER IN AN ACTION OF CONTRACT, TORT OR OTHERWISE, ARISING FROM, OUT OF THE USE OR INABILITY TO USE THE FONT SOFTWARE OR FROM OTHER DEALINGS IN THE FONT SOFTWARE.

Except as contained in this notice, the names of Gnome, the Gnome Foundation, and Bitstream Inc., shall not be used in advertising or otherwise to promote the sale, use or other dealings in this Font Software without prior written authorization from the Gnome Foundation or Bitstream Inc., respectively. For further information, contact: fonts at gnome dot org.



How to Access the PDF Operation Manuals

PDF operation manuals in several languages are included in the CD-ROM. To utilize these manuals, you need to install Adobe® Reader® on your computer (Windows® or Macintosh®).

Please download Adobe® Reader® from the Internet (<http://www.adobe.com>).

Accessing the PDF Manuals

For Windows®:

- ① Insert the CD-ROM in the CD-ROM drive.
- ② Double click the “My Computer” icon.
- ③ Double click the “CD-ROM” drive.
- ④ **When you want to view the operation manual**
 - 1) Double click the “MANUALS” folder.
 - 2) Double click the language (name of the folder) that you want to view.
 - 3) Double click the pdf file to access the projector manuals.

When you want to view the SETUP MANUAL

- 1) Double click the “SETUP” folder.
- 2) Double click the language (name of the folder) that you want to view.
- 3) Double click the pdf file to access the SETUP MANUAL.

For Macintosh®:

- ① Insert the CD-ROM in the CD-ROM drive.
- ② Double click the “CD-ROM” icon.
- ③ **When you want to view the operation manual**
 - 1) Double click the “MANUALS” folder.
 - 2) Double click the language (name of the folder) that you want to view.
 - 3) Double click the pdf file to access the projector manuals.

When you want to view the SETUP MANUAL

- 1) Double click the “SETUP” folder.
- 2) Double click the language (name of the folder) that you want to view.
- 3) Double click the pdf file to access the SETUP MANUAL.

Note

- If the desired pdf file cannot be opened by double clicking the mouse, start Adobe® Reader® first, then specify the desired file using the “File”, “Open” menu.

SETUP MANUAL

Refer to the “SETUP MANUAL” contained on the supplied CD-ROM for details.

Connecting Pin Assignments	2
RS-232C Specifications and Commands	4
Setting up the Projector Network Environment	10
Controlling the Projector via LAN	16
Setting up the Projector Using RS-232C or Telnet	21
Resetting the Lamp Timer of the Projector via LAN	31
Troubleshooting	33

Accessories

Supplied accessories



Remote control
<RRMCGA843WJSA>



Two R-6 batteries
("AA" size, UM/SUM-3,
HP-7 or similar)

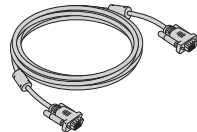

RGB cable
(10' (3.0 m))
<QCNWGA086WJPZ>

Power cord*

(1)

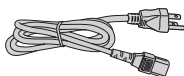

For U.S. and
Canada, etc.
(6' (1.8 m))

<QACCDAA007WJPZ>

(2)

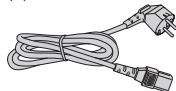

For Europe,
except U.K.
(6' (1.8 m))

<QACCVAA011WJPZ>

(3)

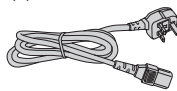

For U.K. and
Singapore
(6' (1.8 m))

<QACCBAA036WJPZ>

(4)

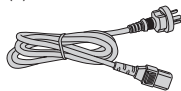

For Australia, New
Zealand and Oceania
(6' (1.8 m))

<QACCLA018WJPZ>

* Which power cords are supplied along with your projector depends on the region. Use the power cord that corresponds to the wall outlet in your country.

- Operation manuals (this manual <TINS-E544WJZZ>, OPERATION MANUAL FOR STEREOSCOPIIC 3D PROJECTION <TINS-E545WJZZ> and CD-ROM <UDSKAA125WJZZ>)

Note

- Codes in "< >" are Replacement parts codes.

Optional accessories

- | | |
|--|-----------------------------|
| ■ Lamp unit | AN-D400LP |
| ■ Ceiling-mount adaptor | AN-60KT |
| ■ Ceiling-mount bracket | AN-XGCM55 (for U.S.A. only) |
| ■ Ceiling-mount unit | AN-TK201 <for AN-60KT> |
| | AN-TK202 <for AN-60KT> |
| ■ Ceiling-mount extension tube | AN-EP101B <for AN-XGCM55> |
| | (for U.S.A. only) |
| ■ Remote receiver | AN-MR2 |
| ■ 3 RCA to mini D-sub 15 pin cable (10' (3.0 m)) | AN-C3CP2 |

Note

- Some of the optional accessories may not be available depending on the region. Please check with your nearest Sharp Authorized Projector Dealer or Service Center.

Part Names and Functions

Numbers in refer to the main pages in this operation manual where the topic is explained.

Projector

Top View

AUTO SYNC button 33
For automatically adjusting images when connected to a computer.

STANDBY/ON button 26
For turning the power on and putting the projector into standby mode.

Power indicator 26, 53

Lamp indicator 26, 53

Temperature warning indicator 53

ECO+QUIET button 32
For lowering the noise of the cooling fan and extending the lamp life.

28 KEYSTONE button
For entering the Keystone Correction mode.

38 ENTER button
For setting items selected or adjusted on the menu.

29 INPUT buttons (▲/▼)
For switching input mode.

38 Adjustment buttons (▲/▼/◀/▶)
For selecting menu items.

29 VOL (Volume) buttons (-◀/▶+)
For adjusting the speaker sound level.

38 RETURN button
For returning to the previous menu screen during menu operations.

38, 51 MENU/HELP button
For displaying adjustment and setting screens, and help screen.

Front View

Exhaust vent 52

Zoom ring 27
For enlarging/reducing the picture.

Focus ring 27
For adjusting the focus.

Adjustment foot 27

Lens shutter 29

15 Remote control sensor

52 Intake vent

27 HEIGHT ADJUST lever

27 Adjustment foot

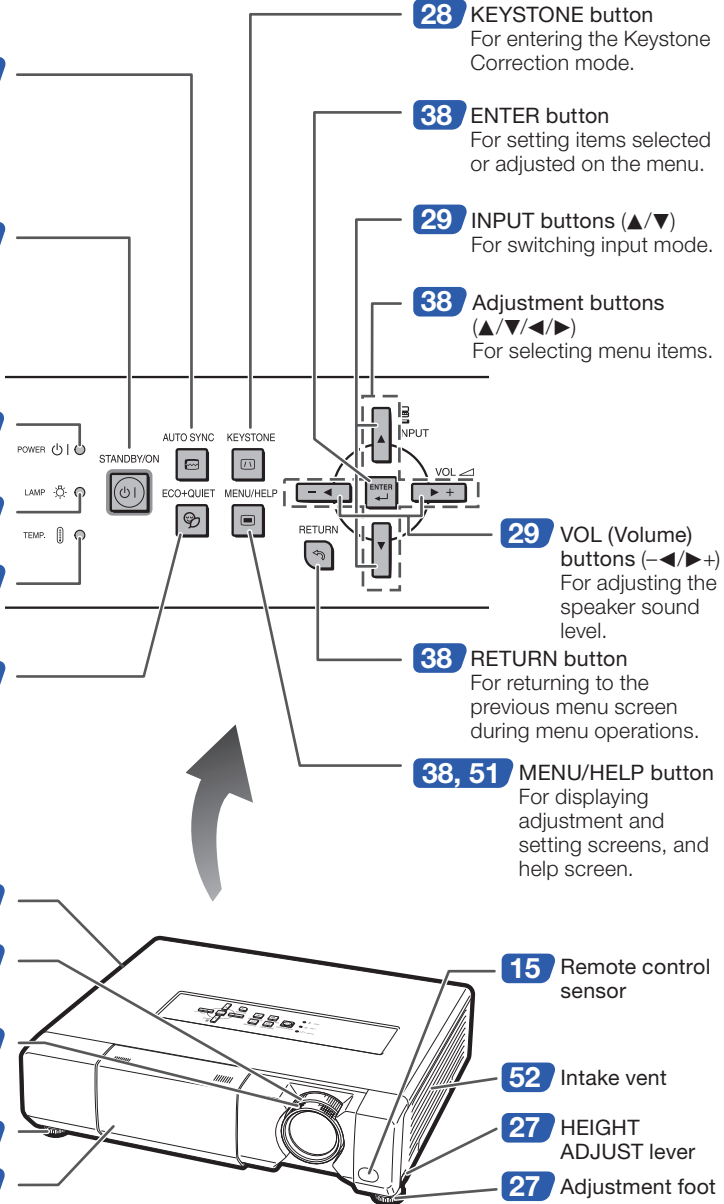

Numbers in refer to the main pages in this operation manual where the topic is explained.

Rear View

Terminals

MONITOR OUT terminal
(Output terminal for computer RGB and component signals. Shared for COMPUTER/COMPONENT1 and 2)
Terminal for connecting a monitor.

COMPUTER/COMPONENT1 and 2 input terminals
Terminals for computer RGB and component signals.

HDMI terminal
Terminal for HDMI input.

AUDIO 1 input terminal

AUDIO OUT terminal

Audio output terminal of equipment connected to the audio input terminal.

AC socket
Connect the supplied power cord.

Speaker

Carrying handle

Remote control sensor

22 VIDEO input terminal
Terminal for connecting video equipment.

22 S-VIDEO input terminal
Terminal for connecting video equipment with an S-video terminal.

23 AUDIO 2 input terminal

25 LAN terminal
Terminal for controlling the projector using a computer via network.

34 USB terminal
Terminal connecting with the USB terminal on the computer for using the supplied remote control as the computer mouse.

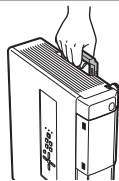
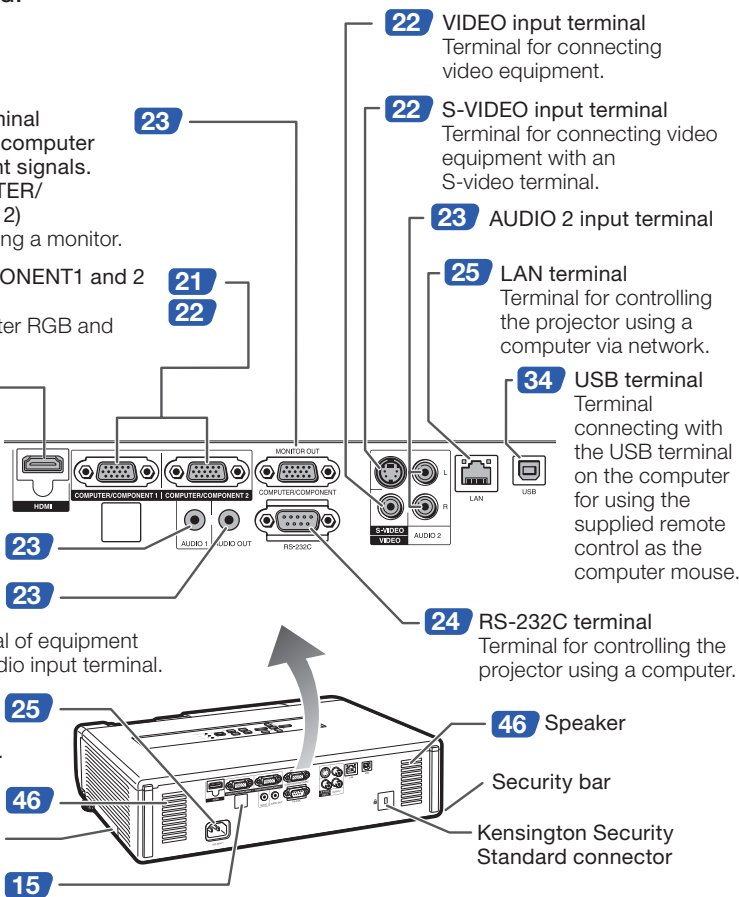

Using the Carrying Handle

When transporting the projector, carry it by the carrying handle on the side.

- Always close the lens shutter to prevent damage to the lens when transporting the projector.
- Do not lift or carry the projector by the lens as this may damage the lens.

Using the Kensington Lock

- This projector has a Kensington Security Standard connector for use with a Kensington MicroSaver Security System. Refer to the information that came with the system for instructions on how to use it to secure the projector.

Part Names and Functions (Continued)

STANDBY button **26**
For putting the projector into the standby mode.

COMPUTER1/2, HDMI, S-VIDEO, VIDEO buttons **29**
For switching to the respective input modes.

BREAK TIMER button **32**
For displaying the break time.

MAGNIFY buttons **33**
For enlarging/reducing part of the image.

PAGE UP/PAGE DOWN buttons **34**
Same as the [Page Up] and [Page Down] keys on a computer keyboard, when with the USB connection (using a USB cable or the optional remote receiver).

POINTER button **32**
For displaying the pointer.

MOUSE/Adjustment buttons **34** **38**

- For moving the computer cursor when with the USB connection (using a USB cable or the optional remote receiver).
- For selecting and adjusting menu items.

L-CLICK/EFFECT button **34** **32**

- For the Left click when with the USB connection (using a USB cable or the optional remote receiver).
- For changing the pointer or spot area.

KEystone button **28**
For entering the Keystone Correction mode.

AUTO SYNC button **33**
For automatically adjusting images when connected to a computer.

ECO+QUIET button **32**
For lowering the noise of the cooling fan and extending the lamp life.

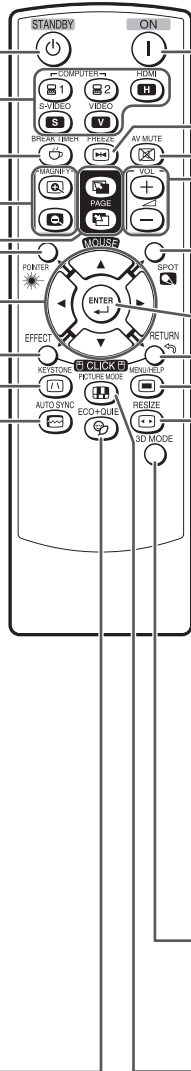

ON button **26**
For turning the power on.

FREEZE button **33**
For freezing images.

AV MUTE button **29**
For temporarily displaying a black screen and turning off the sound.

VOL +/- (Volume) buttons **29**
For adjusting the speaker sound level.

SPOT button **32**
For displaying the spotlight.

ENTER button **38**
For setting items selected or adjusted on the menu.

R-CLICK/RETURN button **34** **38**

- For the Right click when with the USB connection (using a USB cable or the optional remote receiver).
- For returning to the previous menu screen during menu operations.

MENU/HELP button **38** **51**
For displaying adjustment and setting screens, and help screen.

RESIZE button **30**
For switching the picture size (NORMAL, STRETCH, etc.).

3D MODE button
See the OPERATION MANUAL FOR STEREOSCOPIC 3D PROJECTION provided separately.

PICTURE MODE button **33**
For selecting the appropriate picture.

Inserting the Batteries

- 1** Pull down the tab on the cover and remove the cover towards the direction of the arrow.
- 2** Insert the batteries.
 - Insert the batteries making sure the polarities correctly match the \oplus and \ominus marks inside the battery compartment.
- 3** Insert the lower tab of the cover into the opening, and lower the cover until it clicks in place.

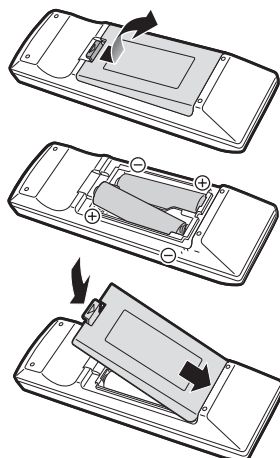

Incorrect use of the batteries may cause them to leak or explode. Please follow the precautions below

Caution

- Danger of explosion if battery is incorrectly replaced. Replace only with alkaline or manganese batteries.
- Insert the batteries making sure the polarities correctly match the \oplus and \ominus marks inside the battery compartment.
- Batteries of different types have different properties, therefore do not mix batteries of different types.
- Do not mix new and old batteries.
- This may shorten the life of new batteries or may cause old batteries to leak.
- Remove the batteries from the remote control once they have run out, as leaving them in can cause them to leak. Battery fluid from leaked batteries is harmful to skin, therefore ensure you wipe them first and then remove them using a cloth.
- The batteries included with this projector may run down in a short period, depending on how they are kept. Be sure to replace them as soon as possible with new batteries.
- Remove the batteries from the remote control if you will not be using the remote control for a long time.
- Comply with the rules (ordinance) of each local government when disposing of worn-out batteries.

Usable Range

The remote control can be used to control the projector within the ranges shown in the illustration.

Note

- Another remote control sensor is located on the rear of the projector. (See page 13.)
- The signal from the remote control can be reflected off a screen for easy operation. However, the effective distance of the signal may differ depending on the screen material.

When using the remote control

- Ensure that you do not drop it or expose it to moisture or high temperature.
- The remote control may malfunction under a fluorescent lamp. In this case, move the projector away from the fluorescent lamp.

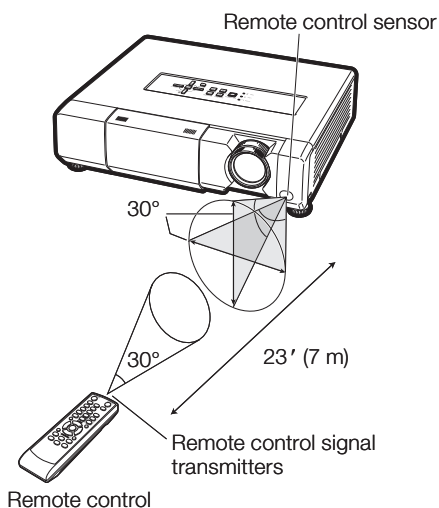

Quick Start

This section shows the basic operation (projector connecting with the computer). For details, see the page described below for each step.

Setup and Projection

In this section, connection of the projector and the computer is explained using one example.

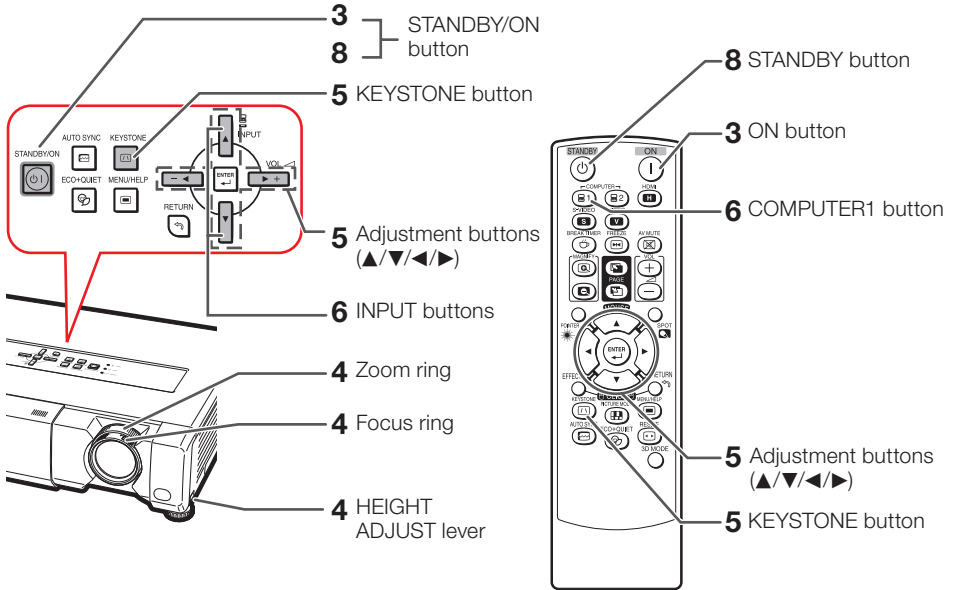

1. Place the projector facing a wall or a screen → P. 18

2. Connect the projector to the computer and plug the power cord into the AC socket of the projector

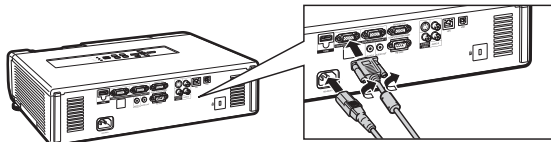

When connecting equipment other than a computer, see pages 22 and 23.

→ PP. 21, 25

3. Open the lens shutter fully and then turn the projector on

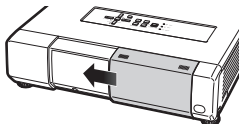

On the projector
STANDBY/ON

On the remote control
ON

→ P. 26

4. Adjust the projected image

- 1 Adjusting the focus.
- 2 Adjusting the height.
- 3 Adjusting the picture size.

➔ P. 27

5. Correct trapezoidal distortion

Correcting trapezoidal distortion using Keystone Correction.

On the projector

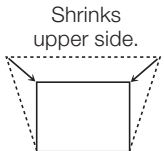
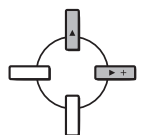

Shrinks upper side.

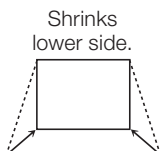
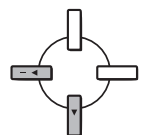

Shrinks lower side.

On the remote control

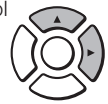

➔ P. 28

6. Select the INPUT mode

Select the "COMPUTER1" using **INPUT** on the projector or **COMPUTER1** on the remote control.

On the projector

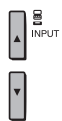

On the remote control

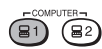

INPUT list

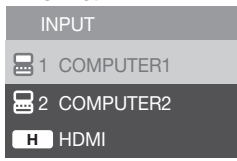

On-screen display (RGB)

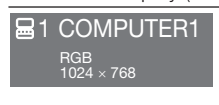

- When you press **INPUT** on the projector, the INPUT list appears. Press ▲/▼ to switch the INPUT mode.

➔ P. 29

7. Turn the computer on

8. Turn the power off

Press **STANDBY/ON** on the projector or **STANDBY** on the remote control, and then press the button again while the confirmation message is displayed to put the projector into standby mode.

On the projector



On the remote control



On-screen display

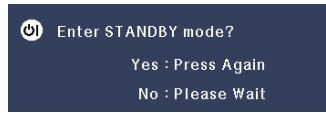

➔ P. 26

Setting up the Projector

Video Setup

If using this projector outside the U.S.A., please change setting to “0 IRE” in Video Setup. (See page 44.)

Setting up the Projector

For optimal image quality, position the projector perpendicular to the screen with the projector's feet flat and level. Doing so will eliminate the need for Keystone correction and provide the best image quality. (See page 28.)

Standard Setup (Front Projection)

- Place the projector at the required distance from the screen according to the desired picture size. (See page 20.)



Example of standard setup

Side View

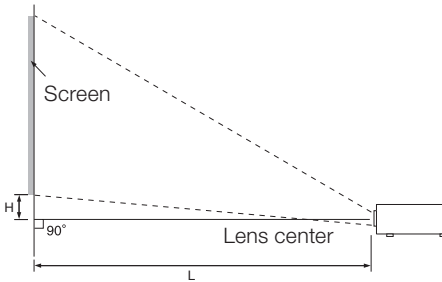

Note

- Refer to page 20 for additional information concerning “Screen Size and Projection Distance”.

Ceiling-mount Setup

- It is recommended that you use the optional Sharp ceiling-mount adaptor and unit for this installation. Before mounting the projector, contact your nearest Sharp Authorized Projector Dealer or Service Center to obtain the recommended ceiling-mount adaptor and unit (sold separately).

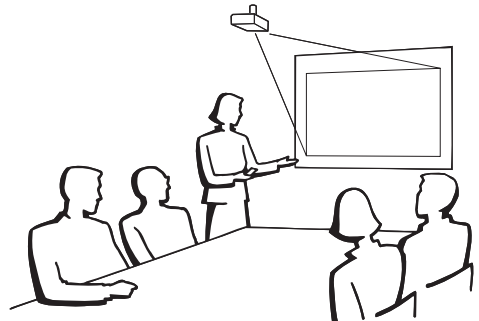

Projection (PRJ) Mode

The projector can use any of the 4 projection modes shown in the diagram below. Select the mode most appropriate for the projection setting in use. (You can set the PRJ mode in "SCR-ADJ" menu. See page 44.)

- Table mounted, front projection
[Menu item → "Front"]

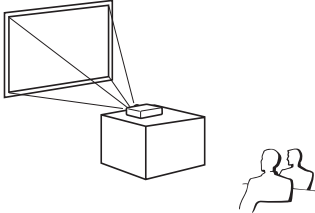

- Ceiling mounted, front projection
[Menu item → "Ceiling + Front"]

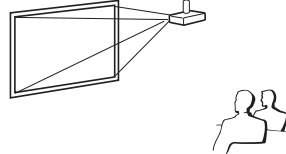

- Table mounted, rear projection (with a translucent screen)
[Menu item → "Rear"]

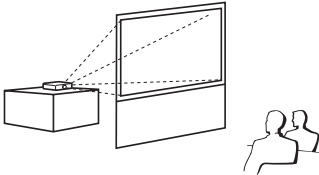

- Ceiling mounted, rear projection (with a translucent screen)
[Menu item → "Ceiling + Rear"]

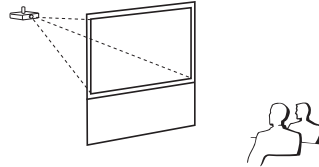

Indication of the Projection Image Size and Projection Distance

Example: 16:10 Signal Input (Normal Mode)

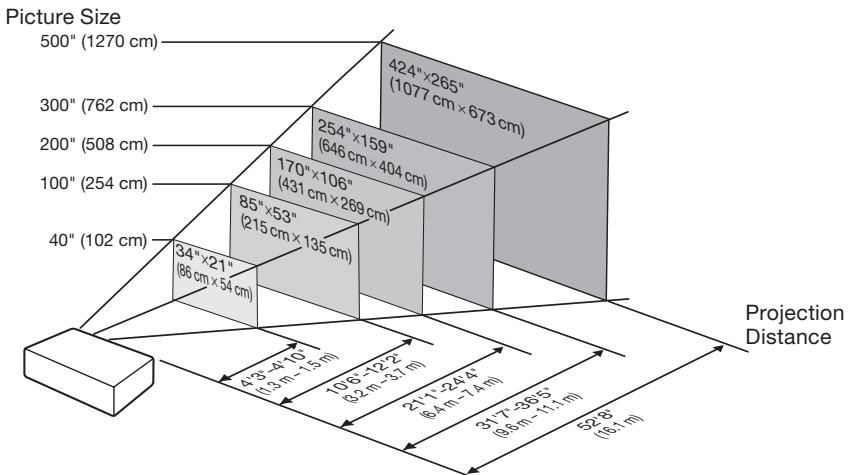

Setting up the Projector (Continued)

Screen Size and Projection Distance

16:10 Signal Input (Normal Mode)

Picture (Screen) size			Projection distance [L]		Distance from the lens center to the bottom of the image [H]
Diag. [X]	Width	Height	Minimum [L1]	Maximum [L2]	
500" (1270 cm)	1077 cm (424")	673 cm (265")	16.1 m (52' 8")	—	84 cm (33 1/32")
400" (1016 cm)	862 cm (339")	538 cm (212")	12.8 m (42' 2")	14.8 m (48' 7")	67 cm (26 27/64")
300" (762 cm)	646 cm (254")	404 cm (159")	9.6 m (31' 7")	11.1 m (36' 5")	50 cm (19 13/16")
250" (635 cm)	538 cm (212")	337 cm (132")	8.0 m (26' 4")	9.3 m (30' 4")	42 cm (16 33/64")
200" (508 cm)	431 cm (170")	269 cm (106")	6.4 m (21' 1")	7.4 m (24' 4")	34 cm (13 7/32")
150" (381 cm)	323 cm (127")	202 cm (79")	4.8 m (15' 10")	5.6 m (18' 3")	25 cm (9 29/32")
120" (305 cm)	258 cm (102")	162 cm (64")	3.9 m (12' 8")	4.4 m (14' 7")	20 cm (7 59/64")
100" (254 cm)	215 cm (85")	135 cm (53")	3.2 m (10' 6")	3.7 m (12' 2")	17 cm (6 39/64")
80" (203 cm)	172 cm (68")	108 cm (42")	2.6 m (8' 5")	3.0 m (9' 9")	13 cm (5 9/32")
60" (152 cm)	129 cm (51")	81 cm (32")	1.9 m (6' 4")	2.2 m (7' 3")	10 cm (3 31/32")
40" (102 cm)	86 cm (34")	54 cm (21")	1.3 m (4' 3")	1.5 m (4' 10")	7 cm (2 41/64")

X: Picture size (diag.) (in/cm)

L: Projection distance (m/ft)

L1: Minimum projection distance (m/ft)

L2: Maximum projection distance (m/ft)

H: Distance from the lens center to the bottom of the image (cm/in)

The formula for picture size and projection distance

[m/cm]

L1 (m) = 0.03212X

L2 (m) = 0.03703X

H (cm) = 0.1678X

[Feet/inches]

L1 (ft) = 0.03212X / 0.3048

L2 (ft) = 0.03703X / 0.3048

H (in) = 0.1678X / 2.54

4:3 Signal Input (Normal Mode)

Picture (Screen) size			Projection distance [L]		Distance from the lens center to the bottom of the image [H]
Diag. [X]	Width	Height	Minimum [L1]	Maximum [L2]	
400" (1016 cm)	813 cm (320")	610 cm (240")	14.5 m (47' 9")	—	76 cm (29 59/64")
300" (762 cm)	610 cm (240")	457 cm (180")	10.9 m (35' 9")	12.6 m (41' 3")	57 cm (22 7/16")
250" (635 cm)	508 cm (200")	381 cm (150")	9.1 m (29' 10")	10.5 m (34' 5")	47 cm (18 45/64")
200" (508 cm)	406 cm (160")	305 cm (120")	7.3 m (23' 10")	8.4 m (27' 6")	38 cm (14 61/64")
150" (381 cm)	305 cm (120")	229 cm (90")	5.5 m (17' 11")	6.3 m (20' 8")	28 cm (11 7/32")
120" (305 cm)	244 cm (96")	183 cm (72")	4.4 m (14' 4")	5.0 m (16' 6")	23 cm (8 31/32")
100" (254 cm)	203 cm (80")	152 cm (60")	3.6 m (11' 11")	4.2 m (13' 9")	19 cm (7 31/64")
80" (203 cm)	163 cm (64")	122 cm (48")	2.9 m (9' 7")	3.4 m (11' 0")	15 cm (5 63/64")
70" (178 cm)	142 cm (56")	107 cm (42")	2.5 m (8' 4")	2.9 m (9' 8")	13 cm (5 15/64")
60" (152 cm)	122 cm (48")	91 cm (36")	2.2 m (7' 2")	2.5 m (8' 3")	11 cm (4 31/64")
40" (102 cm)	81 cm (32")	61 cm (24")	1.5 m (4' 9")	1.7 m (5' 6")	8 cm (2 63/64")

X: Picture size (diag.) (in/cm)

L: Projection distance (m/ft)

L1: Minimum projection distance (m/ft)

L2: Maximum projection distance (m/ft)

H: Distance from the lens center to the bottom of the image (cm/in)

The formula for picture size and projection distance

[m/cm]

L1 (m) = 0.03636X

L2 (m) = 0.04192X

H (cm) = 0.18996X

[Feet/inches]

L1 (ft) = 0.03636X / 0.3048

L2 (ft) = 0.04192X / 0.3048

H (in) = 0.18996X / 2.54

Note

- Refer to page 18 concerning "Projection distance [L]" and "Distance from the lens center to the bottom of the image [H]".
- Allow a margin of error in the values in the diagrams above.

Connecting the Projector to Other Equipment

Before connecting, ensure that the power cord of the projector is unplugged from the AC outlet and turn off the equipment to be connected. After making all connections, turn on the projector and then the other pieces of equipment. When connecting a computer, ensure that it is the last equipment to be turned on after all the connections are made.





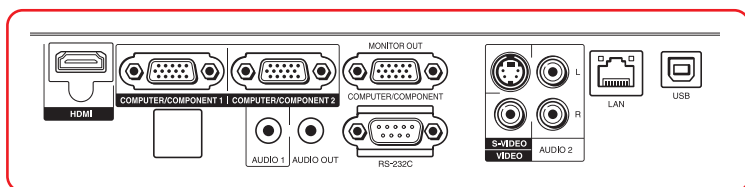

IMPORTANT:

Ensure that the appropriate input mode has been selected on the projector before you turn on the connected equipment.

- For more details of connection and cables, refer to the operation manual of the connecting equipment.
- You may need other cables or connectors not listed below.

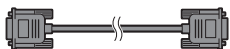
Terminals on the Projector













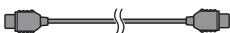

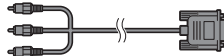







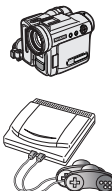

Equipment	Terminal on connected equipment	Cable	Terminal on the projector
	RGB output terminal 	RGB cable (supplied) 	COMPUTER/COMPONENT1 or 2 
	HDMI output terminal 	HDMI cable (commercially available) 	HDMI 

Note



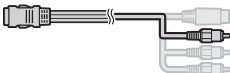







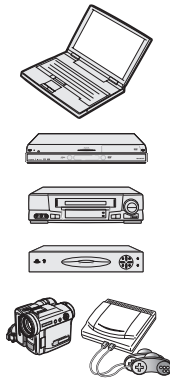



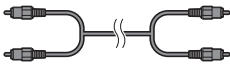

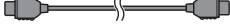

- Depending on specifications of equipment or the DVI⇄HDMI digital cable, the signal transmission may not work properly. (The HDMI specification does not support all connections to equipment that has digital output terminal using a DVI⇄HDMI digital cable.)
- See page 58 “Computer Compatibility Chart” for a list of computer signals compatible with the projector. Use with computer signals other than those listed may cause some of the functions to not work.
- A Macintosh adaptor may be required for use with some Macintosh computers. Contact your nearest Macintosh Dealer.
- **Depending on the computer you are using, an image may not be projected unless the computer’s external output port is switched on (e.g. Press “Fn” and “F5” keys simultaneously when using a SHARP notebook computer).** Refer to the specific instructions in your computer’s operation manual to enable your computer’s external output port.

Connecting the Projector to Other Equipment (Continued)

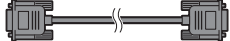
Equipment	Terminal on connected equipment	Cable	Terminal on the projector
Video equipment 	HDMI output terminal 	HDMI cable (commercially available) 	HDMI 
	Component video output terminal 	3 RCA to mini D-sub 15 pin cable (optional, AN-C3CP2) 	COMPUTER/COMPONENT1 or 2 
	S-video output terminal 	S-video cable (commercially available) 	S-VIDEO 
	Video output terminal 	Video cable (commercially available) 	VIDEO 
Camera/Video game 	Component video output terminal 	Cables for a camera or a video game/3 RCA to mini D-sub 15 pin cable (optional, AN-C3CP2)  RCA adaptor plug (commercially available)	COMPUTER/COMPONENT1 or 2 
	S-video output terminal 	Cables for a camera or a video game 	S-VIDEO 
	Video output terminal 	Cables for a camera or a video game 	VIDEO 

Note

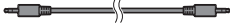
- Depending on specifications of equipment or the DVI⇔HDMI digital cable, the signal transmission may not work properly. (The HDMI specification does not support all connections to equipment that has digital output terminal using a DVI⇔HDMI digital cable.)
- HDMI (High-Definition Multimedia Interface) is a digital AV interface that can deliver a high-definition video signal, multi-channel audio signal, and bi-directional control signal all in just one cable.
- Because it is compatible with the HDCP (High-bandwidth Digital Content Protection) system, the digital video signal does not degrade when transmitted, and a high-quality image with a simple connection can be enjoyed.
- When you connect video equipment with a 21-pin RGB output (Euro-scart) to the projector, use a commercially available cable that fits in the projector terminal you want to connect.
- The projector does not support RGBC signals via the Euro-scart.

Equipment	Terminal on connected equipment	Cable	Terminal on the projector
	ø3.5 mm audio output terminal 	ø3.5 mm stereo or mono audio cable (commercially available or available as Sharp service part QCNWGA038WJPZ) 	AUDIO 1 
	RCA audio output terminal 	RCA audio cable (commercially available) 	AUDIO 2 
	Audio output terminal 	Cables for a camera or a video game 	
	HDMI output terminal 	HDMI cable (commercially available) 	HDMI 
Monitor 	RGB input terminal 	RGB cable (supplied or commercially available) 	MONITOR OUT 
Amplifier 	ø3.5 mm audio input terminal 	ø3.5 mm stereo or mono audio cable (commercially available or available as Sharp service part QCNWGA038WJPZ) 	AUDIO OUT 
	RCA audio input terminal 	ø3.5 mm stereo minijack to RCA audio cable (commercially available) 	

 **Note**

- When using the ø3.5 mm mono audio cable, the volume level will be half of when using the ø3.5 mm stereo audio cable.
- You can select “Audio 1”, “Audio 2” or “HDMI” for “Audio Input” in the “PRJ-ADJ” menu. (See page 46.)
- RGB signals and Component signals can be output to the monitor. HDMI input video signal would not be output.

This projector is able to process the following signals when connected to HDMI equipment:

- Video signal: For details, see “Digital Support” in the list of “Computer Compatibility Chart” on page 58.
- Audio signal: Linear PCM audio
- Sampling frequency: 48kHz/44.1kHz/32kHz

Controlling the Projector by a Computer

When the RS-232C terminal on the projector is connected to a computer with an RS-232C serial control cable (cross type, commercially available), the computer can be used to control the projector and check the status of the projector. Refer to the “SETUP MANUAL” contained on the supplied CD-ROM for “RS-232C Specifications and Commands”.

When connecting to a computer using an RS-232C serial control cable

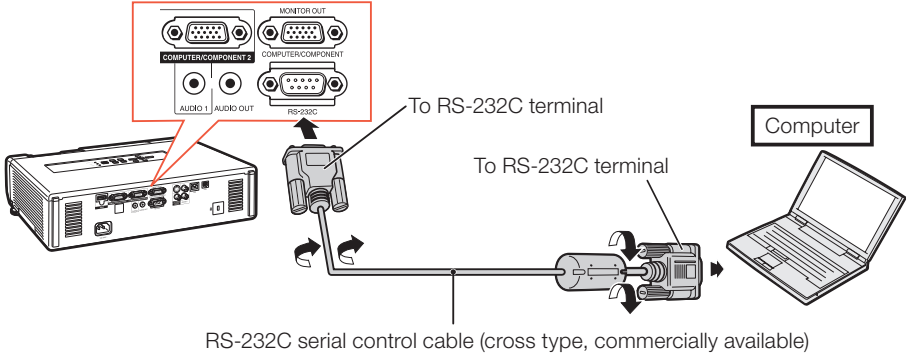

Note

- The RS-232C function may not operate if your computer terminal is not correctly set up. Refer to the operation manual of the computer for details.
- Refer to pages **2** to **9** of the “SETUP MANUAL” contained on the supplied CD-ROM for “Connecting Pin Assignments” and “RS-232C Specifications and Commands”.

Info

- Do not connect the RS-232C cable to a port other than the RS-232C terminal on the computer. This may damage your computer or projector.
- Do not connect or disconnect an RS-232C serial control cable to or from the computer while it is on. This may damage your computer.

When connecting to the LAN terminal using a LAN cable

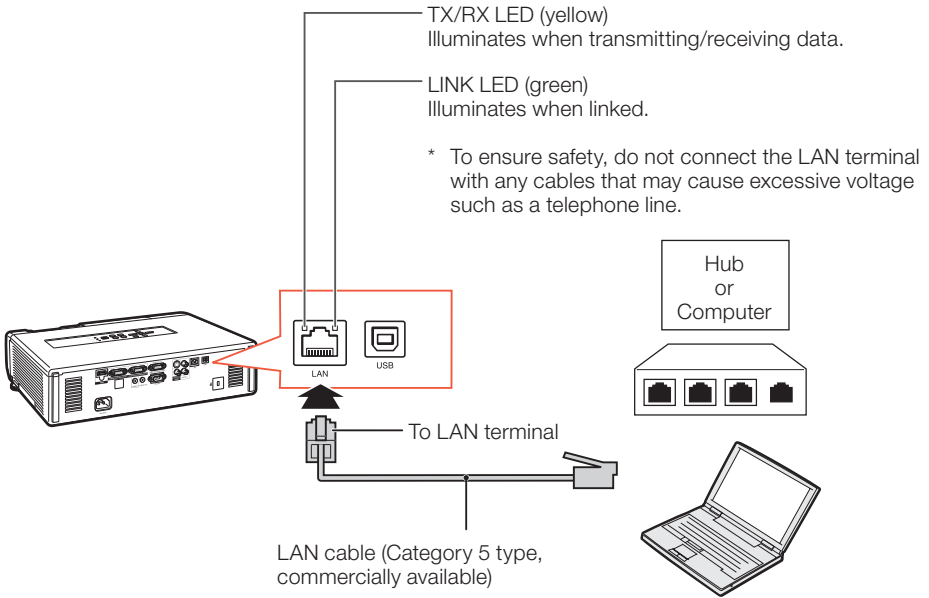

Note

- When connecting to a hub, use a straight-through Category 5 (CAT.5) type cable (commercially available).
- When connecting to a computer, use a cross-over Category 5 (CAT.5) type cable (commercially available).

Connecting the Power Cord

Plug the supplied power cord into the AC socket on the rear of the projector. Then plug into AC outlet.

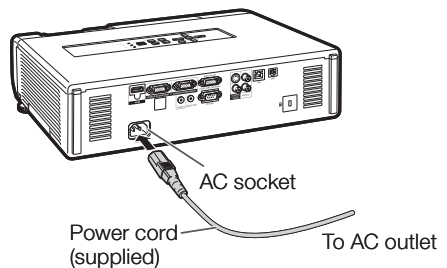

Turning the Projector On/Off

Turning the Projector On

Note that the connections to external equipment and power outlet should be done before performing the operations written below. (See pages 21 to 25.)

Open the lens shutter fully and press **STANDBY/ON** on the projector or **ON** on the remote control.

- The power indicator illuminates green.
- After the lamp indicator illuminates, the projector is ready to start operation.

Note

About the Lamp Indicator

The lamp indicator illuminates to indicate the status of the lamp.

Green: The lamp is on.

Blinking in green: The lamp is warming up.

Red: The lamp is shut down abnormally or the lamp should be replaced.

- When switching on the projector, a slight flickering of the image may be experienced within the first minute after the lamp has been illuminated. This is normal operation as the lamp's control circuitry is stabilising the lamp output characteristics. It should not be regarded as faulty operation.
- If the projector is put into standby mode and immediately turned on again, the lamp may take some time to start projection.
- When System Lock is set, the keycode input box appears. To cancel the keycode setting, input the keycode that you have already set. See page 46 for details.

Info

When "Auto Restart" is set to "On":

- If the power cord is unplugged from the outlet or the breaker switch is turned off when the projector is on, then the projector automatically turns on when the power cord is plugged into the AC outlet or the breaker switch is turned on. (See page 45.)
- English is the factory default language. If you want to change the on-screen display to another language, change the language according to the procedure on page 44.

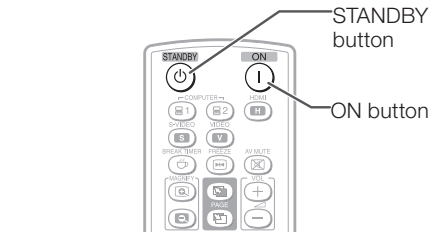
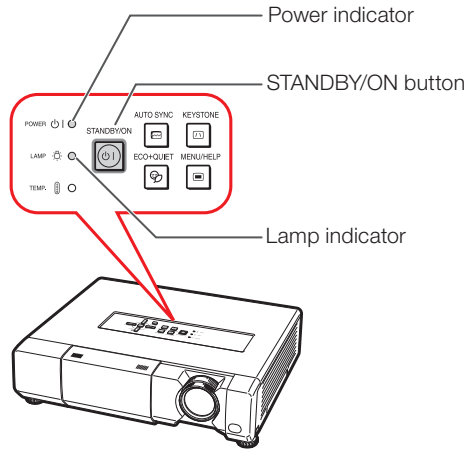

On-screen display (confirmation message)



Enter STANDBY mode?

Yes : Press Again

No : Please Wait

Turning the Power Off (Putting the Projector into Standby Mode)

Press **STANDBY/ON** on the projector or **STANDBY** on the remote control, then press that button again while the confirmation message is displayed, to put the projector into standby mode.

- The projector cannot be turned on while cooling.

Info

Direct Power Off function:

- You can unplug the power cord from the AC outlet even if the cooling fan is still running.

Image Projection

Adjusting the Projected Image

1 Adjusting the Focus

You can adjust the focus with the focus ring on the projector.

Rotate the focus ring to adjust the focus while watching the projected image.

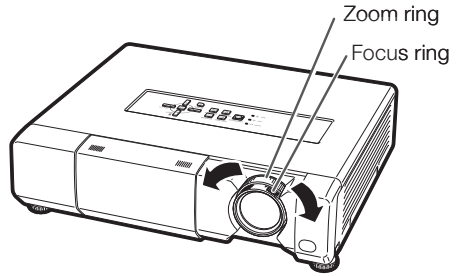

2 Adjusting the Height

The height of the projector can be adjusted using the adjustment feet.

When the screen is above the projector, the projection image can be made higher by adjusting the projector.

- 1 Lift the projector to adjust its height while lifting the HEIGHT ADJUST lever.**

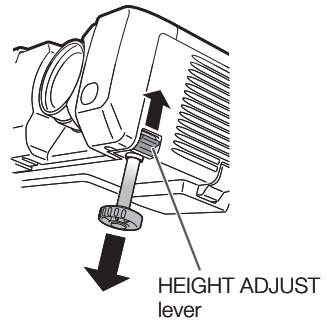

- 2 Remove your hands from the HEIGHT ADJUST lever of the projector after its height has been finely adjusted.**

- The angle of projection is adjustable up to 9 degrees from the surface on which the projector is placed.

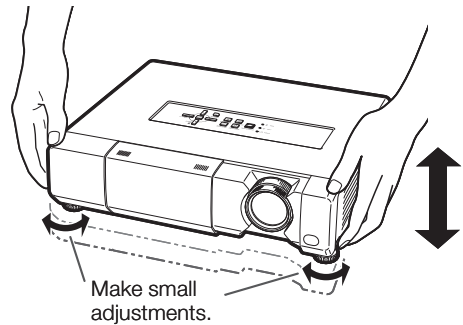

Note

- When adjusting the height of the projector, trapezoidal distortion occurs. Follow the procedures in Keystone Correction to correct the distortion. (See pages 28 and 43.)

3 Adjusting the Picture Size

You can adjust the picture size using the zoom ring on the projector.

Rotate the zoom ring to enlarge or shrink the picture size.

Info

- Do not apply too much pressure on the projector when the front adjustment feet come out.
- When lowering the projector, be careful not to get your fingers caught in the area between the adjustment feet and the projector.
- Hold the projector firmly while lifting or carrying.
- Do not hold by the lens area.

Image Projection (Continued)

Correcting Trapezoidal Distortion

When the image is projected either from the top or from the bottom towards the screen at an angle, the image becomes distorted trapezoidally. The function for correcting trapezoidal distortion is called Keystone Correction.

Note

- The Keystone Correction can be adjusted up to an angle of approximately ± 40 degrees and the screen can also be set up to an angle of approximately ± 40 degrees (when the resize mode is set to "NORMAL" (see page 30)).

1 Press **KEYSTONE** to enter the Keystone Correction mode.

- You can also display the on-screen display of the Keystone Correction mode with **KEYSTONE** on the projector.

2 Press **▲/▶** or **◀/▼** to adjust the Keystone Correction.

- You can also adjust the Keystone Correction using the adjustment buttons on the projector.

Note

- To return to the default setting, press **RETURN** while the on-screen display of the Keystone Correction mode is on the screen.

3 Press **KEYSTONE**.

- The on-screen display of the Keystone Correction mode will disappear.
- You can also use **KEYSTONE** on the projector.

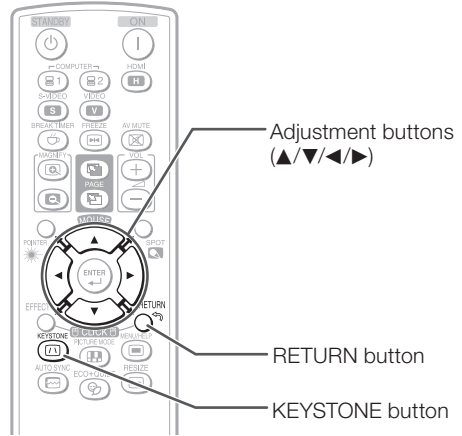

On-screen display
(Keystone Correction mode)



Shrinks upper side.
(Move the slide bar in the + direction.)

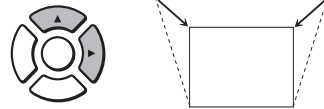

Shrinks lower side.
(Move the slide bar in the - direction.)

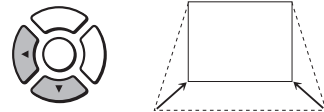

Info

- While adjusting the image using Keystone Correction, straight lines and the edges of the image may appear jagged.

Switching the Input Mode

Select the appropriate input mode for the connected equipment.

Press **COMPUTER1/2**, **HDMI**, **S-VIDEO** or **VIDEO** on the remote control to select the input mode.

- When you press **INPUT** on the projector, the INPUT list appears.
Press **▲/▼** to switch the INPUT mode.

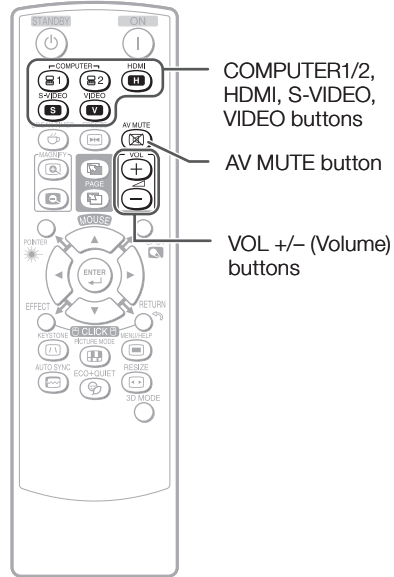

Adjusting the Volume

Press **VOL +/-** on the remote control or **-◀/▶+** on the projector to adjust the volume.

Note

- Pressing **VOL-/-◀** will lower the volume.
- Pressing **VOL+/>▶+** will raise the volume.
- When the projector is connected to external equipment, the volume level of the external equipment changes in accordance with the volume level of the projector. Set the projector's volume to the lowest level when turning the projector on/off or when changing the input signal.
- When you do not want to output the sound from the projector's speaker while the projector is connected to external equipment, set "Speaker" in "PRJ-ADJ" menu to "Off". (See page 46.)

On-screen display



Displaying the Black Screen and Turning Off the Sound Temporarily

Press **AV MUTE** on the remote control or close the lens shutter to temporarily display a black screen and turn off the sound.

Note

- Pressing **AV MUTE** again will turn the projected image back on.
- When you close the lens shutter, the projector will be AV MUTE mode and then the projector will be turned off automatically after about 30 minutes.

On-screen display



Image Projection (Continued)

Resize Mode

This function allows you to modify or customize the resize mode to enhance the input image. Depending on the input signal, you can choose a desired image.





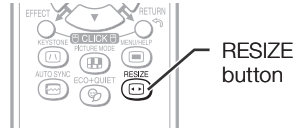





















Press **RESIZE**.

- See page 43 for setting on menu screen.



COMPUTER

		NORMAL	FULL	DOT BY DOT	STRETCH
4:3 aspect ratio	SVGA (800 × 600)	1068 × 800	1280 × 800	800 × 600	1280 × 720
	XGA (1024 × 768)			1024 × 768	
	SXGA (1152 × 864)			1152 × 864	
	SXGA+ (1400 × 1050)			1400 × 1050	
Other aspect ratios	SXGA (1280 × 1024)	1000 × 800	1280 × 800	1280 × 1024	—
	1280 × 720	1280 × 720		—	
	1360 × 768	1280 × 722	1360 × 768	—	
	1366 × 768	1280 × 720	1366 × 768		
	1280 × 768	1280 × 768	—		
	1280 × 800	1280 × 800	—	1280 × 720	

Input signal		Output screen image			
Computer	Image type	NORMAL	FULL	DOT BY DOT	STRETCH
Resolution XGA and below	 4:3 aspect ratio				 *1
Resolution higher than XGA				 *3	
SXGA (1280 × 1024)	 5:4 aspect ratio				 *1
1280 × 720	 16:9 aspect ratio	 *1		—*2	 *2
1360 × 768 1366 × 768	 16:9 aspect ratio				
1280 × 768	 15:9 aspect ratio	 *1		 *2	 *1
1280 × 800	 16:10 aspect ratio		 *2		 *1

■: Cutout area on which images cannot be projected































⋯: Area where the signals are off screen

*1 The Image Shift function can be used for these images.

*2 Same as NORMAL mode.

*3 In case SXGA+ input.

VIDEO/DTV

Input signal		Output screen image			
Video/DTV	Image type	NORMAL	AREA ZOOM	V-STRETCH	STRETCH
480i, 480P, 576i, 576P, NTSC, PAL, SECAM	 4:3 aspect ratio				 *1
	 Squeeze				 *1
	 Letter box				 *1
720P, 1035i, 1080i, 1080P	 16:9 aspect ratio	 *1			—*2
	 16:9 aspect ratio	 *1			
540P	 16:9 aspect ratio	 *1			—*2
	 16:9 aspect ratio (4:3 aspect ratio in 16:9)	 *1			

 : Cutout area on which images cannot be projected

 : Area on which the image is not included in the original signals

*1 The Image Shift function can be used for these images.

*2 Same as NORMAL mode.

About Copyrights

- When using the RESIZE function to select an image size with a different aspect ratio to a TV program or video image, the image will look different from its original appearance. Keep this in mind while choosing an image size.
- The use of the Resize or Keystone Correction function to compress or stretch the image for commercial purposes/public displays in a café, hotel, etc. may be an infringement of copyright protected by law for copyright holders. Please use caution.

Operating with the Remote Control

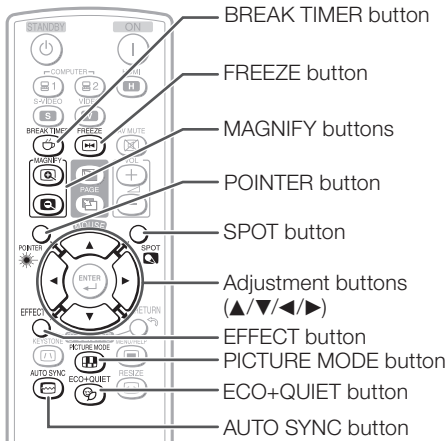

Displaying the Pointer

- 1 Press **POINTER** and press ▲/▼/◀/▶ on the remote control to move the pointer.
 - Press **EFFECT** to change the pointer icon (5 types).

Star	Finger1	Finger2	Heart	Underline

- 2 Press **POINTER** again.
 - The pointer will disappear.

Displaying and Setting the Break Timer

- 1 Press **BREAK TIMER**.
 - The timer starts to count down from 5 minutes.

On-screen display



- 2 Press ▲/▼/◀/▶ to adjust the length of the break time.
 - **Increases with ▲ or ▶**
5 minutes → 6 minutes → 60 minutes
 - **Shortens with ◀ or ▼**
4 minutes → 3 minutes → 1 minute
 - The break time can be set in units of one minute (up to 60 minutes).

Canceling the break timer display function

Press **BREAK TIMER**.

Note

- The Break Timer is not available while the projector is operating the following functions.
 - Auto Sync
 - Freeze
 - AV Mute

Using the Spot Function

- 1 Press **SPOT** and press ▲/▼/◀/▶ on the remote control to move the spot area.
 - Press **EFFECT** to change the spot area size (3 types).

1/9	1/25	1/8

- 2 Press **SPOT** again.
 - The spot area will disappear.

Switching the Eco+Quiet Mode

Press **ECO+QUIET** to switch the Eco+Quiet mode between on and off.

- When the Eco+Quiet Mode is set to "ON", the sound of the cooling fan will turn down, the power consumption will decrease, and the lamp life will extend.

Note

- Refer to "Eco+Quiet" on page 42 for details.

Auto Sync (Auto Sync Adjustment)

Auto Sync function works when detecting input signal after the projector turns on.

Press **AUTO SYNC** to manually adjust with Auto Sync function.

Note

- When the optimum image cannot be achieved with Auto Sync adjustment, use the help menu for manual adjustments. (See page 51.)

Freezing a Moving Image

1 Press FREEZE.
• The projected image is frozen.

2 Press FREEZE again to return to the moving image from the currently connected device.

Selecting the Picture Mode

You can select the appropriate picture mode for the projected image, such as movie or video game.

Press **PICTURE MODE**.

- When pressing **PICTURE MODE**, the picture mode changes in the following order:

→ STANDARD → PRESENTATION → MOVIE → GAME → sRGB*



Note

- See page 40 for details on the picture mode.



* "sRGB" is displayed only when RGB signal is input.





Displaying an Enlarged Portion of an Image

Graphs, tables and other portions of projected images can be enlarged. This is helpful when providing more detailed explanations.

1 Press  MAGNIFY on the remote control.
• Enlarges the image.
• Pressing  or  MAGNIFY enlarges or reduces the projected image.

Note

Press .
→
×1 ×2 ×3 ×4
←
Press .

- You can change the location of the enlarged image using , ,  and .

2 Press RETURN on the remote control to cancel the operation.
• The magnification then returns to ×1.

Note

- The selectable magnifications differ depending on the input signal.
- In the following cases, the image will return to the normal size (×1).
 - When switching the INPUT mode.
 - When **RETURN** has been pressed.
 - When the input signal is changed.
 - When the input signal resolution and refresh rate (vertical frequency) change.
 - When the Resize mode is changed.
 - When the Picture mode is changed.
 - When the Progressive mode is changed.

Operating with the Remote Control (Continued)

Using the Remote Control as the Wireless Computer Mouse

When connecting the projector and the computer with a USB cable, you can use the remote control as the computer mouse.

If the computer is placed too far away from the projector to be connected via the USB cable, the remote receiver (optional, AN-MR2) makes it possible to operate the projector with the remote control. For details, see the operation manual of the receiver.

Connecting with a USB cable

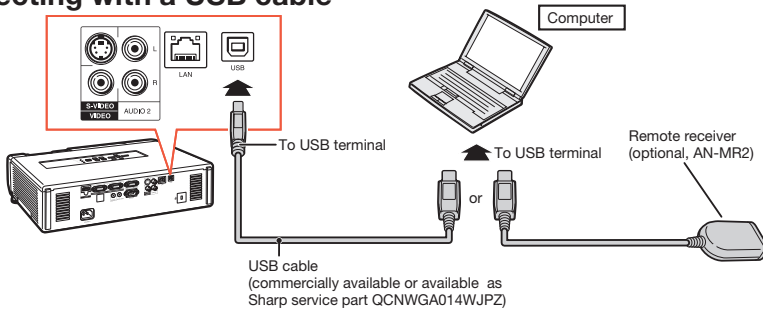

The mouse pointer can be operated in the following way after it is connected.

- **When moving the cursor**
Press MOUSE/Adjustment buttons (▲/▼/◀/▶).
- **When left-clicking**
Press L-CLICK.
- **When right-clicking**
Press R-CLICK.
- **When your computer supports only a one-click mouse (such as Macintosh)**
Press L-CLICK or R-CLICK.
L-CLICK and R-CLICK have common function.
- **When using [Page Up] or [Page Down]**
Same as the [Page Up] and [Page Down] keys on a computer keyboard.
Press PAGE UP or PAGE DOWN.

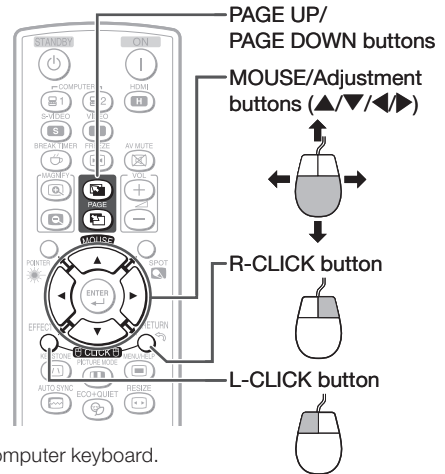

Note

- This function only works with the Microsoft® Windows® OS and Mac OS®. However, this function does not work with the following operation systems that do not support USB.
 - Versions earlier than Windows® 95
 - Versions earlier than Windows® NT4.0
 - Versions earlier than Mac OS® 8.5
- You cannot use this function when displaying the menu screen.
- Confirm that the computer recognizes the USB connection.

Menu Items

The following shows the items that can be set in the projector.

“Picture” menu

PAGE 1

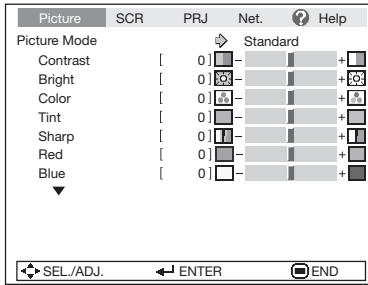

PAGE 2

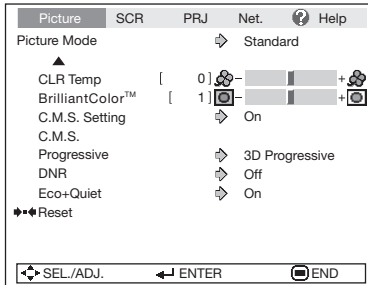

“C.M.S.”

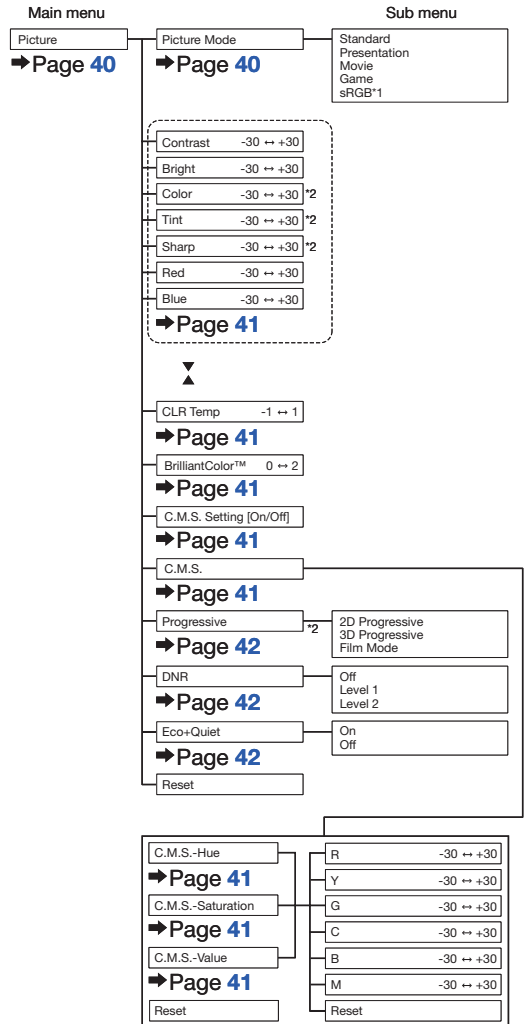
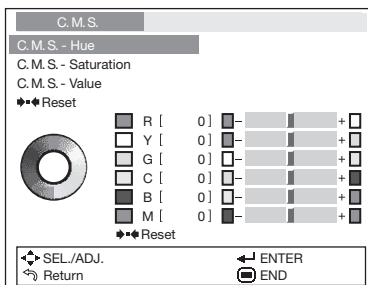

*1 Items when inputting RGB signal through COMPUTER1/2 or HDMI.

*2 Items when inputting video component signal through COMPUTER1/2 or HDMI, or when selecting S-VIDEO or VIDEO.

Menu Items (Continued)

“Screen adjustment (SCR-ADJ)” menu

Pict.	SCR-ADJ	PRJ	Net.	Help
Resize		↕	Stretch	
Image Shift	[0]	↔		+ & -
Keystone	[0]	↕		+ & -
Overscan		↕	On	
OSD Display		↕	On	
Closed Caption		↕	Off	
Background		↕	Logo	
PRJ Mode		↕	Front	
DLP® Link™		↕	Off	
DLP® Link™ Invert		↕		
Video Setup		↕	0 IRE	
Language		↕	English	
↕ SEL./ADJ. ← ENTER END				

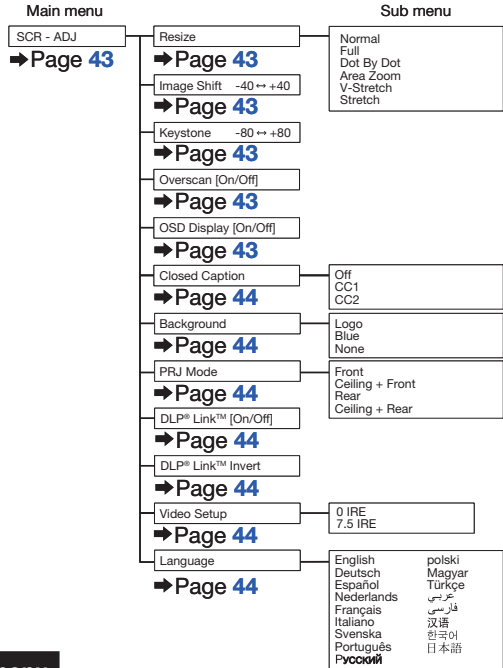

“Projector adjustment (PRJ-ADJ)” menu

Pict.	SCR	PRJ-ADJ	Net.	Help
Auto Sync		↕	On	
Auto Power Off		↕	On	
Auto Restart		↕	On	
STANDBY Mode		↕	Standard	
System Sound		↕	On	
Audio Out		↕	VAO	
Speaker		↕	On	
Audio Input		↕	Audio 1	
RS-232C		↕	9600bps	
Fan Mode		↕	Normal	
System Lock		↕	Disable	
Lamp Timer(Life) [0] h [0] min (100%)				
↕ SEL./ADJ. ← ENTER END				

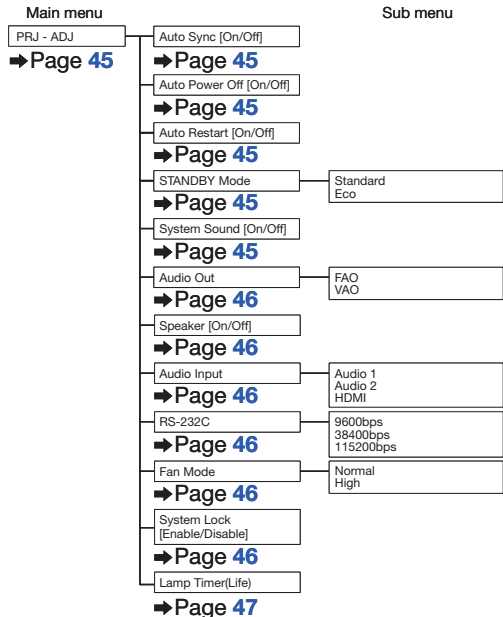

“Network” menu

Pict.	SCR	PRJ	Network	?	Help
Password			Disable		
DHCP Client			Off		
TCP/IP					
MAC Address XX : XX : XX : XX : XX : XX					
Projector XX-XXXX					
⏪ SEL./ADJ. ↵ ENTER ⏩ END					

“Help” menu

Pict.	SCR	PRJ	Net.	?	Help
<ul style="list-style-type: none"> • There is no picture or audio • Vertical stripes or flickering image appear • Data image is not centered • Color is faded or poor • Picture is dark • The image is distorted • It is difficult to hear audio • Set up HDMI CEC function 					
<ul style="list-style-type: none"> • Reset all adjustments to default settings 					
⏪ SEL. ↵ ENTER ⏩ END					

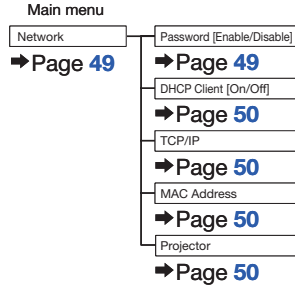

The items you can set with the “Help” menu

“Help” menu → Page 51

- Vertical stripes or flickering image appear
Auto Sync/Clock/Phase
- Data image is not centered
Auto Sync/H-Pos/V-Pos/Resolution
- Color is faded or poor
COMPUTER1/2 input
Signal type: Auto/RGB/Component
S-VIDEO or VIDEO input
Video System: Auto/PAL/SECAM/
NTSC3.58/NTSC4.43/
PAL-M/PAL-N/PAL-60
- HDMI input
Dynamic range: Auto/Standard/Enhanced
- * The selectable items vary depending on the input signal and the selected input mode.
- It is difficult to hear audio
Balance/Treble/Bass
- Set up HDMI CEC function
One Touch Play
On : This enables One Touch Play.
Off : This disables One Touch Play.
System Standby
On : This enables System Standby.
Off : This disables System Standby.
- * When enabling One Touch Play/System Standby, be sure to enable the CEC setting on the HDMI-compliant Sharp Video Products connected to the projector.

Using the Menu Screen

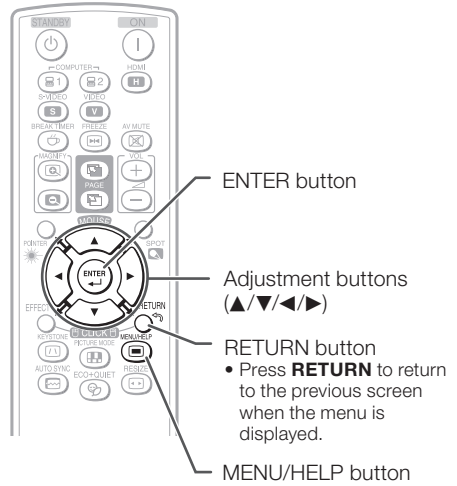
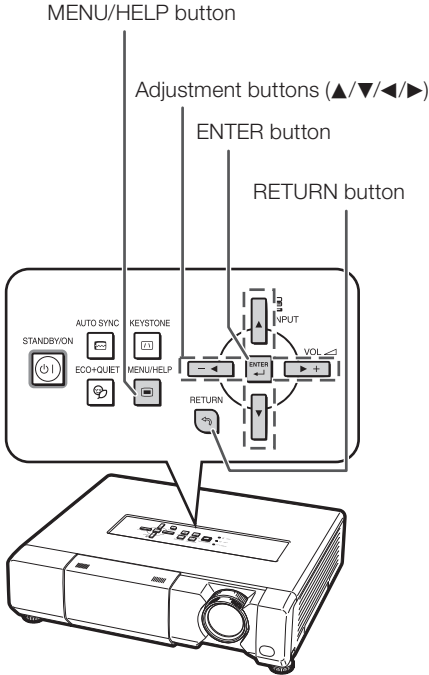

Menu Selections (Adjustments)

Example: Adjusting “Bright”.

- This operation can also be performed by using the buttons on the projector.

1 Press **MENU/HELP**.

- The “Picture” menu screen for the selected input mode is displayed.

2 Press **▶** or **◀** and select “Picture” to adjust.

Example: “Picture” screen menu for COMPUTER (RGB) input

Menu item

Picture	SCR	PRJ	Net.	Help
Picture Mode		⇄	Standard	
Contrast	[0]	▣	▣	+ ▣
Bright	[0]	☼	▣	+ ☼
Red	[0]	▣	▣	+ ▣
Blue	[0]	▣	▣	+ ▣
CLR Temp	[0]	☼	▣	+ ☼
BrilliantColor™	[1]	▣	▣	+ ▣
C.M.S. Setting		⇄	On	
C.M.S.		⇄	Off	
DNR		⇄	Off	
Eco+Quiet		⇄	On	
◆◆◆ Reset				
◆◆◆ SEL./ADJ. ◀ ENTER END				

3 Press ▲ or ▼ and select “Bright” to adjust.

- The selected item is highlighted.

To adjust the projected image while watching it

Press ENTER.

- The selected item (e.g. “Bright”) is displayed by itself at the bottom of the screen.
- When pressing ▲ or ▼, the following item (“Red” after “Bright”) will be displayed.



Note

- Press **ENTER** again to return to the previous screen.

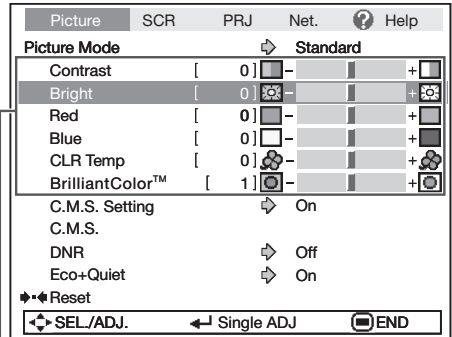

Items to be adjusted

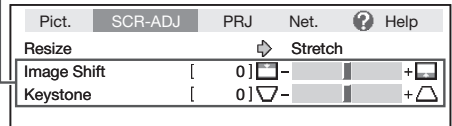

Press **ENTER**.

The item displayed by itself

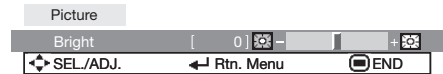

4 Press ◀ or ▶ to adjust the item selected.

- The adjustment is stored.

5 Press MENU/HELP.

- The menu screen will disappear.

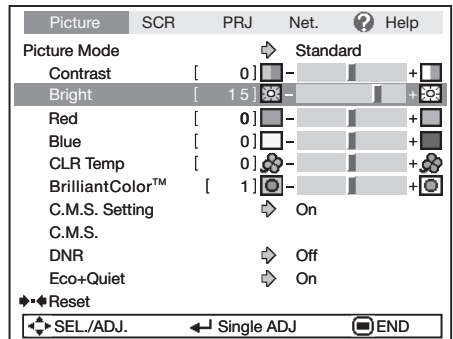

Note

- The **MENU/HELP** button is not available while the projector is operating:
 - Auto Sync/Break Timer/Freeze/AV Mute

Picture Adjustment (“Picture” Menu)

▶ PAGE1

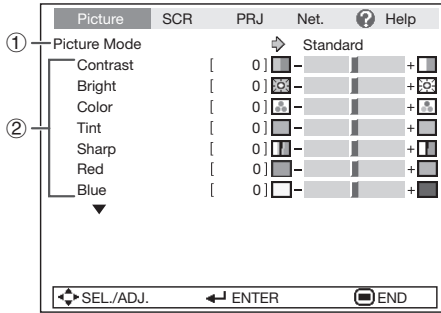

▶ PAGE2

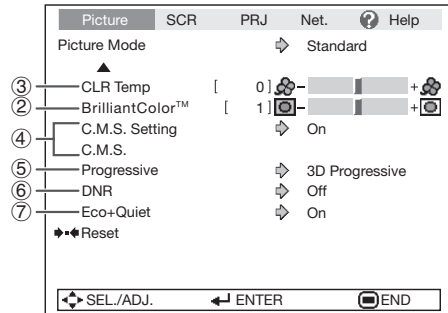

① Selecting the Picture Mode

Selectable items	Description	The default settings of each item when selecting Picture Mode		
		CLR Temp	BrilliantColor™	Eco+Quiet
Standard	For standard image	0	1	Off
Presentation	Brightens portions of image for more enhanced presentations.	0	2	Off
Movie	Gives natural tint to the projected image.	-1	0	On
Game	Gives sharpness to the projected image.	0	1	Off
*sRGB	For high fidelity reproduction of images from a computer.	-	-	Off

- “sRGB” is displayed only when RGB signal is input.
- You can set or adjust each item in the “Picture” menu to your preference. Any changes you make are retained in memory.

Note

- You can also press **PICTURE MODE** on the remote control to select the picture mode. (See page 33.)
- *sRGB is an international standard of color reproduction regulated by the IEC (International Electrotechnical Commission). As the fixed color area has been decided by the IEC, the images are displayed in a natural tint based on an original image, when “sRGB” is selected. For additional information about the sRGB function, visit “<http://www.srgb.com/>”. You cannot set the items, “Red”, “Blue”, “CLR Temp”, “BrilliantColor™”, when “sRGB” is selected.

Info

- When “sRGB” is selected, the projected image may become dark, but this does not indicate a malfunction.

② Adjusting the Image

Adjustment items	◀ button	▶ button
Contrast	For less contrast.	For more contrast.
Bright	For less brightness.	For more brightness.
Color*1	For less color intensity.	For more color intensity.
Tint*1	For making skin tones purplish.	For making skin tones greenish.
Sharp*1	For less sharpness.	For more sharpness.
Red*2	For weaker red.	For stronger red.
Blue*2	For weaker blue.	For stronger blue.
BrilliantColor™*2 *3	For making the effect weaker.	For making the effect stronger.

*1 Not displayed in the RGB input mode.

*2 Not adjustable/selectable when selecting “sRGB”.

*3 BrilliantColor™ uses Texas Instruments' BrilliantColor™ technology. As the BrilliantColor™ level is increased, the image becomes brighter while the color reproduction is kept at a high level.



Note

- “Red”, “Blue”, “BrilliantColor™” and “CLR Temp” cannot be set when “sRGB” is selected.
- To reset all adjustment items, select “Reset” and press **ENTER**.

③ Adjusting the Color Temperature

Selectable items	Description
-1	For lower color temperature for warmer, reddish incandescent-like images.
0	↕
1	For higher color temperature for cooler, bluish, fluorescent-like images.



Note

- Values on “CLR Temp” are only for general standard purposes.

④ Adjusting the Colors

This function adjusts each of the six main colors that comprise the color wheel, altering their “Hue”, “Saturation”, or “Value”.

Selectable items	Description
C.M.S.-Hue	Sets the hue of the main colors.
C.M.S.-Saturation	Sets the saturation of the main colors.
C.M.S.-Value	Sets the brightness of the main colors.
Reset	The adjustments of “Hue”, “Saturation” and “Value” of all colors are reset to the default setting.

Adjusting “Hue”, “Saturation”, or “Value”.

- 1 Select “On” for “C.M.S. Setting” in the “Picture” menu and then press **ENTER**.
- 2 Select “C.M.S.” in the “Picture” menu and then press **ENTER**.
- 3 Press ▲ or ▼ to select either “Hue”, “Saturation”, or “Value” and then press **ENTER**.
- 4 Select the color to be adjusted with ▲ or ▼ and adjust it with ◀ or ▶.

Example of adjusting the “Hue”

Main colors	◀ button	▶ button
R (Red)	Closer to magenta	Closer to yellow
Y (Yellow)	Closer to red	Closer to green
G (Green)	Closer to yellow	Closer to cyan
C (Cyan)	Closer to green	Closer to blue
B (Blue)	Closer to cyan	Closer to magenta
M (Magenta)	Closer to blue	Closer to red

- When “Saturation” is selected, the selected color becomes
◀: lighter. ▶: thicker.
- When “Value” is selected, the selected color becomes
◀: darker. ▶: brighter.
- To reset the adjustment values of each color to the default settings, select “Reset” and press **ENTER**.

Picture Adjustment (“Picture” Menu) (Continued)

Menu operation → Page 38

⑤ Progressive

Selectable items	Description
2D Progressive	Useful to display fast-moving images such as sports.
3D Progressive	Useful to display relatively slow-moving images such as drama and documentary more clearly.
Film Mode	Reproduces the image of film source* clearly. Displays the optimized image of film transformed with three-two pull down (NTSC and PAL60Hz) or two-two pull down (PAL50Hz and SECAM) enhancement to progressive mode images.

* The film source is a digital video recording with the original encoded as is at 24 frames/second. The projector can convert this film source to progressive video at 60 frames/second with NTSC and PAL60Hz or at 50 frames/second with PAL50Hz and SECAM to play back a high-definition image.

Note

- In NTSC or PAL60Hz, even if the 3D Progressive mode has been set, the three-two pull down enhancement will be enabled automatically when the film source has been entered.
- When the image is blurred or noisy, switch to the optimal mode.

Info

- This function is available for 480I and 576I signals using COMPUTER/COMPONENT input.
- This function is available for all signals with S-VIDEO and VIDEO input.

⑥ Reducing Image Noise (DNR)

Video digital noise reduction (DNR) provides high quality images with minimal dot crawl and cross color noise.

Selectable items	Description
Off	The DNR function is not activated.
Level 1	Sets the DNR level for viewing a clearer picture.
Level 2	

Note

Set “DNR” to “Off” in the following cases:

- When the image is blurry.
- When the contours and colors of moving images drag.
- When TV broadcasts with weak signals are projected.

⑦ Eco+Quiet

Selectable items	Brightness and Power consumption
On	Approx. 75%
Off	100%

Note

- When “Eco+Quiet” is set to “On”, the fan sound and power consumption are lower than they are when “Off” is selected. (Projection brightness decreases as shown in the chart.)

Adjusting the Projected Image (“SCR - ADJ” Menu)

Menu operation → Page 38

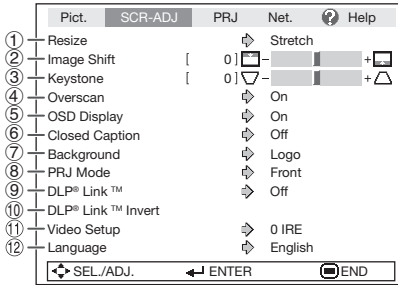

① Setting the Resize Mode

Use this function to stretch the image vertically or horizontally or when the edges of the image cannot be seen.

Note

- For details of the Resize mode, see pages 30 and 31.
- You can also press **RESIZE** on the remote control to set the Resize mode. (See page 30.)

② Adjusting the Image Position

You can move the projected image vertically.

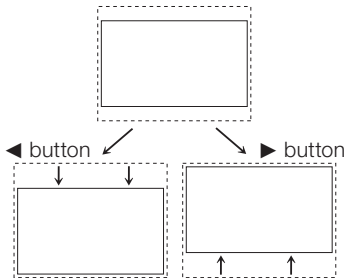

Note

- This function only works in some Resize modes. (See pages 30 and 31.)

③ Keystone Correction

When the image is projected either from the top or from the bottom towards the screen at an angle, the image becomes distorted trapezoidally. The function for correcting trapezoidal distortion is called Keystone Correction.

Select “Keystone” on the “SCR-ADJ” menu and adjust with the slide bar. See page 28 for details of Keystone Correction.

Note

- The Keystone Correction can be adjusted up to an angle of approximately ± 40 degrees (when “Resize” is set to “Normal”).
- You can also press **KEYSTONE** on the remote control or on the projector to adjust Keystone Correction.

④ Setting the Overscan

This function allows you to set the overscan area (display area).

Selectable items	Description
On	The input area is displayed without the screen edges.
Off	The whole input area is displayed.

Note

- You can set “Overscan” for the following input signals (Computer, DVI-D Video and DVI-Analog). —480P, 540P, 576P, 720P, 1035I and 1080I/1080P
- If noise appears at the screen edges when “Off” is selected, set the function to “On”.
- Also see “About Copyrights” on page 31.

⑤ Setting the On-screen Display

Selectable items	Description
On	All on-screen displays are displayed.
Off	INPUT/VOLUME/AV MUTE/FREEZE/AUTO SYNC/RESIZE/PICTURE MODE/ECO+QUIET/MAGNIFY/ “An invalid button has been pressed.” are not displayed.

Adjusting the Projected Image (“SCR - ADJ” Menu) (Continued)

Menu operation → Page 38

⑥ Closed Caption

<For Americas only>

Info

- This function is available for NTSC3.58 and 480I signals.
- This function is available in the following cases only:

Resize mode	Keystone Correction
Normal Area Zoom V-Stretch	-65 – +65
Stretch	-50 – +50

- “Closed Caption” is a system which allows conversations, narration, and sound effects in TV programs (Limited regions) and home videos to be viewed as captions on the screen.
- Not all programs and videos will offer closed captioning. Please look for the **CC** symbol to ensure that captions will be shown.
- Two channels are available: CC1 and CC2.
- The Closed Caption letters of this projector are displayed in black and white.

Selectable items	Description
Off	—
CC1	Closed Caption mode for CH1 data
CC2	Closed Caption mode for CH2 data

Note

- Closed Caption may malfunction (white blocks, strange characters, etc.) if signal conditions are poor or if there are problems at the broadcast source. This does not necessarily indicate a problem with the projector.
- If any button is pressed to call up the on-screen display while viewing a Closed Caption broadcast, the closed captions will disappear.

⑦ Selecting the Background Image

Selectable items	Description
Logo	Sharp logo screen
Blue	Blue screen
None	—

⑧ Reversing/Inverting Projected Images

Selectable items	Description
Front	Normal image (Projected from the front of the screen)
Ceiling + Front	Inverted image (Projected from the front of the screen with an inverted projector)
Rear	Reversed image (Projected from the rear of the screen or with a mirror)
Ceiling + Rear	Reversed and inverted image (Projected with a mirror)

See page 19 for details of Projection (PRJ.) Mode.

⑨ DLP® Link™

See the OPERATION MANUAL FOR STEREOSCOPIC 3D PROJECTION provided separately.

⑩ DLP® Link™ Invert

See the OPERATION MANUAL FOR STEREOSCOPIC 3D PROJECTION provided separately.

⑪ Setting the Video Setup

Selectable items	Description
0 IRE	Sets the black level to 0 IRE.
7.5 IRE	Sets the black level to 7.5 IRE.

Note

- This function is available for the following signals.
With COMPUTER/COMPONENT 1 or 2 input:
- 480I
With S-VIDEO or VIDEO input:
- NTSC3.58

⑫ Selecting the On-screen Display Language

The projector can switch the on-screen display language among 17 languages.

Adjusting the Projector Function (“PRJ - ADJ” Menu)

Menu operation → Page 38

	Pict.	SCR	PRJ-ADJ	Net.	Help
①	Auto Sync		↔	On	
②	Auto Power Off		↔	On	
③	Auto Restart		↔	On	
④	STANDBY Mode		↔	Standard	
⑤	System Sound		↔	On	
⑥	Audio Out		↔	VAO	
⑦	Speaker		↔	On	
⑧	Audio Input		↔	Audio 1	
⑨	RS-232C		↔	9600bps	
⑩	Fan Mode		↔	Normal	
⑪	System Lock		↔	Disable	
⑫	Lamp Timer(Life)	[0]h	[0]min (100%)		

① Auto Sync (Auto Sync Adjustment)

Selectable items	Description
On	Auto Sync adjustment will occur when the projector is turned on or when the input signals are switched, when connected to a computer.
Off	Auto Sync adjustment is not automatically performed.

Note

- Auto Sync adjustment is also performed by pressing **AUTO SYNC**.
- The Auto Sync adjustment may take some time to complete, depending on the image of the computer connected to the projector.
- When the optimum image cannot be achieved with Auto Sync adjustment, use manual adjustments. (See page 51.)

② Auto Power Off Function

Selectable items	Description
On	When no input signal is detected for more than 15 minutes, the projector will automatically enter standby mode.
Off	The Auto Power Off function will be disabled.

Note

- When the Auto Power Off function is set to “On”, 5 minutes before the projector enters standby mode, the message “Enter STANDBY mode in X min.” will appear on the screen to indicate the remaining minutes.

③ Auto Restart Function

Selectable items	Description
On	If the power cord is unplugged from the outlet or the breaker switch is turned off when the projector is on, then the projector automatically turns on when the power cord is plugged into the AC outlet or the breaker switch is turned on.
Off	The projector does not turn on automatically when the power cord is plugged into the AC outlet or the breaker switch is turned on.

④ STANDBY Mode

When set to “Eco”, power consumption is reduced in standby mode.

Selectable items	Description
Eco	The monitor output and Network functions are switched off in standby mode.
Standard	The monitor output and Network functions are activated even if the projector is in standby mode.

⑤ Setting the Confirmation Sound (System Sound)

Selectable items	Description
On	A confirmation sound is made when the projector turns on/off.
Off	No confirmation sound is made.

Adjusting the Projector Function (“PRJ - ADJ” Menu) (Continued)

Menu operation → Page 38

⑥ Audio Output Type Setting

This function determines whether the audio level output from the AUDIO output (MONITOR output) terminal is fixed or variable by linking with VOLUME.

Selectable items	Description
FAO (Fixed Audio Output)	Audio output that does not vary in strength with the volume level of the source projector.
VAO (Variable Audio Output)	Audio output that varies in strength with the volume level of the source projector.

Info

- When “Audio Out” has been set to “VAO”, first make sure to lower the volume of the projector before turning the power on or off and when switching the input.

⑦ Speaker Setting

Selectable items	Description
On	The audio signal is output from the internal speaker.
Off	The audio signal is not output from the internal speaker.

⑧ Audio Input

This function allows you to select an appropriate combination of audio input terminals for each input mode.

Selectable items	Description
Audio 1	The AUDIO 1 input terminal is used as an audio input terminal
Audio 2	The AUDIO 2 input terminal is used as an audio input terminal.
HDMI	HDMI terminal is used as an audio input terminal. (This item is available with HDMI input.)

⑨ Selecting the Transmission Speed (RS-232C)

Make sure that both the projector and computer are set for the same baud rate.

Selectable items	Description
9600bps 38400bps 115200bps	Transmission speed is slow. ↑ ↓ Transmission speed is rapid.

⑩ Fan Mode Setting

This function changes the fan rotation speed.

Selectable items	Description
Normal	Suitable for normal environments.
High	Set when using the projector at altitudes of approximately 1,500 meters (4,900 feet) or more.

When “Fan Mode” is set to “High”, the fan rotation speeds up, and the fan noise becomes louder.

⑪ System Lock Function

This function prevents unauthorized use of the projector. Once this function is activated, users must enter the correct keycode each time the projector is turned on. **We suggest you record the keycode in a safe place where only authorized users have access.**

Info

- If you lose or forget your keycode, contact your nearest Sharp Authorized Projector Dealer or Service Center (see page 61). Even if the product warranty is valid, the keycode reset will incur a charge.

■ Setting/Changing the keycode

1 Select “System Lock”, then press **ENTER** or **▶**.

2 Select “Next”, then press **ENTER**.
• The screen for entering the keycode appears.

3 Press the 4 buttons on the remote control or on the projector to enter the preset keycode in “Old Code”.

- When setting the keycode for the first time, press ▼ on the projector for four times.

PRJ - ADJ	
Setting the System Lock	
Old Code	- - - -
New Code	- - - -
Reconfirm	- - - -

Note

- If you input a wrong keycode, the cursor returns to the first point of the “Old Code”.
- The preset keycode is 4 ▼ buttons on the projector. When you press the ▼ button four times, the keycode input screen disappears.

4 Press the 4 buttons on the remote control or on the projector to enter the new keycode in “New Code”.

Note

- You cannot use the following buttons for keycode: **STANDBY/ON, ON, STANDBY, ENTER, L-CLICK, R-CLICK/RETURN and MENU/HELP**
- **System lock function recognizes each button on the remote control or on the projector as an individual button, even if they share the same button name. If you used the buttons on the projector in setting your keycode, the keycode cannot be canceled with the remote control.**

PRJ - ADJ	
Setting the System Lock	
Old Code	* * * *
New Code	- - - -
Reconfirm	- - - -

5 Enter the same keycode in “Reconfirm”.

Note

To cancel the keycode that you have already set

- Press ▼ on the projector for four times in steps 4 and 5 above.

When the System Lock is set

- When System Lock is set, the keycode input screen appears after the power is turned on. When it appears, enter the right keycode to start projection.

Input screen for keycode

System Lock	
	- - - -

12 Checking the Lamp Life Status

You can confirm the cumulative lamp usage time and the remaining lamp life (percentage).

Lamp usage condition	Remaining lamp life		
	“Life”	100%	5%
Operated exclusively with “Eco +Quiet” set to “On”	Approx. 3,000 hours	Approx. 150 hours	
Operated exclusively with “Eco +Quiet” set to “Off”	Approx. 2,000 hours	Approx. 100 hours	

Note

- It is recommended that the lamp be changed when the remaining lamp life becomes 5%.
- The lamp life may vary depending on the usage condition.

Adjusting the Projector Function (“PRJ - ADJ” Menu) (Continued)

Keylock Function

Locking the Operation Buttons on the Projector

Use this function to lock the operation buttons on the projector.

■ Locking the Operation Buttons

Hold down **ENTER** on the projector for about 5 seconds while the projector is being turned on.

On-screen display

Keylock function ON

- The keylock function does not affect the operation with the remote control buttons.
- You cannot use the keylock function while the projector is warming up.

■ Taking the Keylock off

Hold down **ENTER** on the projector for about 5 seconds.

On-screen display

Keylock function OFF

- When the projector is in standby mode, you can release the keylock by holding down **ENTER** and **STANDBY/ON** on the projector simultaneously for about 5 seconds.

Info

- Keylock cannot be set while the projector is: displaying the “Menu” screens, in standby mode, warming up, changing input signals, operating “Auto Sync” function, in “FREEZE” mode or on the “System Lock” screen during warming up.

Setting up the Projector Network Environment (“Network” Menu)

Menu operation → Page 38

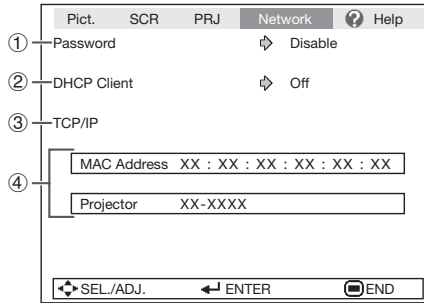

1 Setting a Password

If you do not want others to change the setting for the “Network” menu, set a password.

Setting a Password

1 Select “Password”, then press **ENTER** or **▶**.

- The screen for entering the password appears.

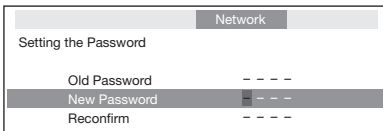

2 Press **▲** or **▼** to set the first digit in “New Password”, then press **▶**.

3 Enter the remaining 3 digits, then press **ENTER**.

- To return to the previous digit, press **◀**.

4 Enter the same password in “Reconfirm”, then press **ENTER**.

- The status for “Password” changes to “Enable”.

Note

- Once the password is set, you must enter the password to change the “Network” menu settings.

Changing the Password

1 Select “Password”, then press **ENTER** or **▶**.

- The screen for entering the password appears.

2 Enter the password in “Old Password” using **▲**, **▼**, **▶** and **◀**, then press **ENTER**.

3 Enter the password in “New Password” using **▲**, **▼**, **▶** and **◀**, then press **ENTER**.

4 Enter the same password again in “Reconfirm” using **▲**, **▼**, **▶** and **◀**, then press **ENTER**.

Note

- If you do not need the password protection for the “Network” menu settings anymore, press **ENTER** without entering the new password in steps 3 and 4.
- To cancel the password settings, press **RETURN**.

If you forget the password

If you forget the password, perform the following procedure to delete it, then set a new password.

On the projector, press



Note

- If **ENTER** is held down for more than 5 seconds, the operation buttons on the projector will be locked. (See page 48.)
- You cannot use the buttons on the remote control to delete the password.

Setting up the Projector Network Environment (“Network” Menu) (Continued)

Menu operation → Page 38

② DHCP Client Setting

Connect the LAN cable before turning the projector on. If not, the DHCP Client function does not work.

Selectable items	Description
On	Obtains configuration parameters for TCP/IP network automatically.
Off	Sets the TCP/IP manually.

Select “On” for “DHCP Client”. “Obtaining IP Address...” appears, then the menu screen appears. Confirm the parameters of IP Address, Subnet Mask and Gateway on the TCP/IP screen.

If the DHCP server is not available, “Could not obtain IP Address.” appears.

In this case, set the TCP/IP manually. (See the item ③.)

③ TCP/IP Setting

Set the TCP/IP manually.

1 Select “Off” for “DHCP Client”, then press **ENTER**.

2 Select “TCP/IP”, then press **ENTER**.

3 Enter “IP Address” using **▲, ▼, ►** and **◀**, then press **ENTER**.

Network	
Setting the TCP/IP	
IP Address	1 9 2 . 1 6 8 . 1 5 0 . 0 0 2
Subnet Mask	2 5 5 . 2 5 5 . 2 5 5 . 0 0 0
Gateway	0 0 0 . 0 0 0 . 0 0 0 . 0 0 0

4 Enter “Subnet Mask” using **▲, ▼, ►** and **◀**, then press **ENTER**.

5 Enter “Gateway” using **▲, ▼, ►** and **◀**, then press **ENTER**.

Selectable items	Description
IP Address	Factory default setting: 192.168.150.002 Enter an IP address appropriate for the network.
Subnet Mask	Factory default setting: 255.255.255.000 Set the subnet mask to the same as that of the computer and equipment on the network.
Gateway	Factory default setting: 000.000.000.000 * When not in use, set to “000.000.000.000”.

Note

- Confirm the existing network's segment (IP address group) to avoid setting an IP address that duplicates the IP addresses of other network equipment or computers. If “192.168.150.002” is not used in a network with an IP address of “192.168.150.XXX”, you don't have to change the projector IP address.
- For details about each setting, consult your network administrator.

④ Confirming the Projector Information

You can confirm the MAC address and projector name.

Selectable items	Description
MAC Address	The MAC address of the projector is displayed.
Projector	The projector name is displayed.

Note

- For information on how to change the projector name, see “SETUP MANUAL” contained in the supplied CD-ROM.

Troubleshooting with the “Help” Menu

This function advises you to solve the problems during usage.

Utilizing the “Help” Menu Functions

Example: When image flickering appears
Operation to solve image flickering when projecting the computer RGB signal.

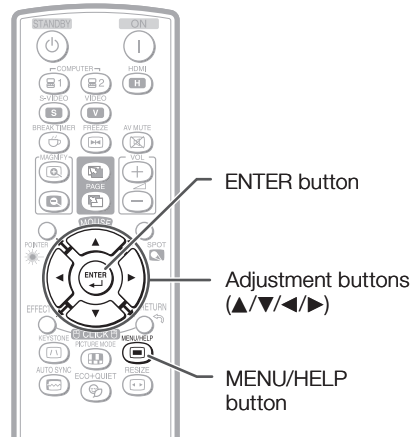

1 Press **MENU/HELP**.

2 Press **◀** or **▶** to select “Help”, then press **ENTER**.

3 Press **▲** or **▼** to select “Vertical stripes or flickering image appears” on Help menu, then press **ENTER**.

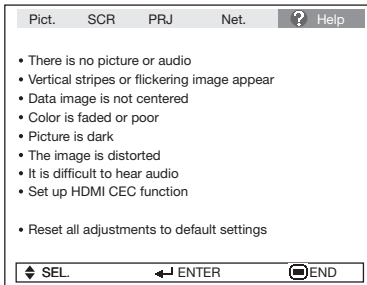

Press **ENTER**.

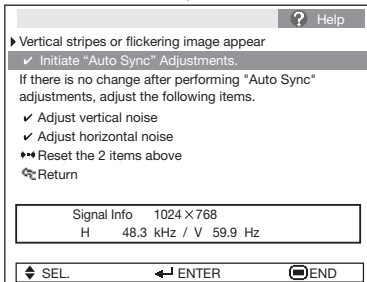

4 Select “Initiate “Auto Sync” Adjustments”, then press **ENTER**.

5 If the image is not improved, select “Adjust horizontal noise”, then press **ENTER**.

6 Press **◀** or **▶** to adjust.



Note

- You can adjust the items with check marks (✓).
- The items in the “Help” menu change, depending on the input signal or setting that you have selected.
- **If the problem is not solved, refer to “Troubleshooting” (see pages 59 and 60).**
- When selecting “sRGB” in “Picture Mode”, the item “Color is faded or poor” is not displayed. This means you cannot change input signal types.

Maintenance

Cleaning the projector

- Ensure that you have unplugged the power cord before cleaning the projector.
- The cabinet as well as the operation panel is made of plastic. Avoid using benzene or thinner, as these can damage the finish on the cabinet.
- Do not use volatile agents such as insecticides on the projector. Do not attach rubber or plastic items to the projector for long periods. The effects of some of the agents in the plastic may cause damage to the quality or finish of the projector.
- Wipe off dirt gently with a soft flannel cloth.
- When the dirt is hard to remove, soak a cloth in a mild detergent diluted with water, wring the cloth well and then wipe the projector. Strong cleaning detergents may discolor, warp or damage the coating on the projector. Make sure to test on a small, inconspicuous area on the projector before use.

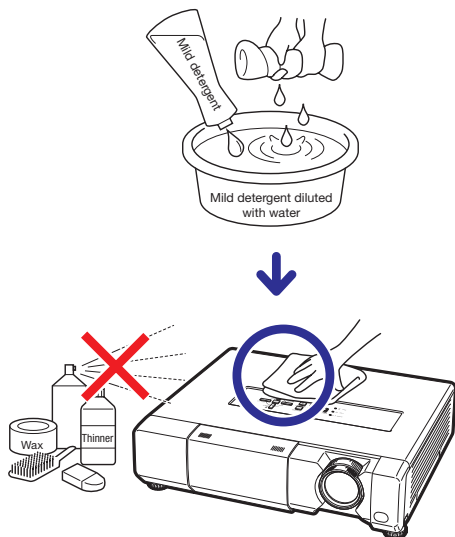

Cleaning the lens

- Use a commercially available blower or lens cleaning paper (for glasses and camera lenses) for cleaning the lens. Do not use any liquid type cleaning agents, as they may wear off the coating film on the surface of the lens.
- As the surface of the lens can easily get damaged, be careful not to scrape or hit the lens.

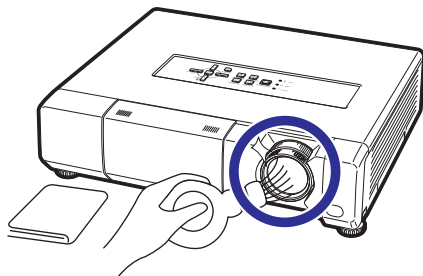

Cleaning the exhaust and intake vents

- Use a vacuum cleaner to clean dust from the exhaust vent and the intake vent.

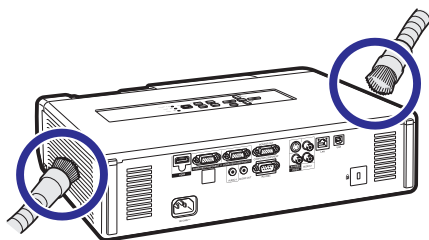

Info

- If you want to clean the air vents during projector operation, ensure you press **STANDBY/ON** on the projector or **STANDBY** on the remote control and put the projector into standby mode. After the cooling fan has stopped, clean the vents.

Maintenance Indicators

- The warning lights (power indicator, lamp indicator and temperature warning indicator) on the projector indicate problems inside the projector.
- If a problem occurs, either the temperature warning indicator or the lamp indicator will illuminate red, and the projector will enter standby mode. After the projector has entered standby mode, follow the procedures given below.

Top View

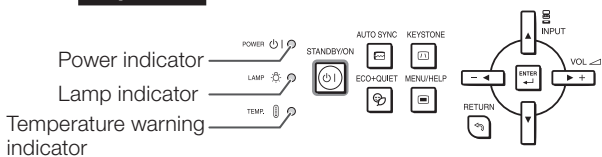



About the temperature warning indicator



If the temperature inside the projector increases, due to blockage of the air vents, or the setting location, the temperature warning indicator will blink. And if the temperature keeps on rising,  will illuminate in the lower left corner of the picture with the temperature warning indicator blinking. If this state continues, the lamp will turn off, the cooling fan will run and then the projector will enter standby mode. When you find the temperature warning indicator blinking, be sure to perform the measures described on page 54.

About the lamp indicator



- When the remaining lamp life becomes 5% or less,  (yellow) and “Change The Lamp” will be displayed on the screen. When the percentage becomes 0%, it will change to  (red), the lamp will automatically turn off and then the projector will automatically enter standby mode. At this time, the lamp indicator will illuminate in red.
- **If you try to turn on the projector a fourth time without replacing the lamp, the projector will not turn on.**

Indicators on the Projector

Power indicator	Red on	Normal (Standby)
	Green on	Normal (Power on)
	Red blinks	Abnormal (See page 54.)
	Green blinks	Normal (Cooling)
	Green and orange blink alternately	The lens shutter is closed. (See page 29.)
Lamp indicator	Green on	Normal
	Green blinks	The lamp is warming up.
	Red on	The lamp is shut down abnormally or requires to be changed. (See page 54.)
Temperature warning indicator	Off	Normal
	Red on/Red blinks	The internal temperature is abnormally high. (See page 54.)

Maintenance Indicators (Continued)

Maintenance indicator			Problem	Cause	Possible Solution
	Normal	Abnormal			
Temperature warning indicator	Off	Red blinks (On)/ Red on (Standby)	The internal temperature is abnormally high.	<ul style="list-style-type: none"> • Temperatures around the projector are high. • Blocked air intake 	<ul style="list-style-type: none"> • Use the projector in an area with a temperature of lower than 95°F (+35°C). • Relocate the projector to an area with proper ventilation. (See page 8.)
				<ul style="list-style-type: none"> • Cooling fan breakdown • Internal circuit failure • Clogged air intake 	
Lamp indicator	Green on (Green blinks when the lamp is warming up.)	Red on	The lamp does not illuminate.	<ul style="list-style-type: none"> • The lamp is shut down abnormally. 	<ul style="list-style-type: none"> • Disconnect the power cord from the AC outlet, and then connect it again. • Carefully replace the lamp. (See page 55.) • Take the projector to your nearest Sharp Authorized Projector Dealer or Service Center (see page 61) for repair. • Please exercise care when replacing the lamp. • Securely install the cover.
		Red on (Standby)	Time to change the lamp. The lamp does not illuminate.	<ul style="list-style-type: none"> • Remaining lamp life becomes 5% or less. • Burnt-out lamp • Lamp circuit failure 	
Power indicator	Green on/ Red on Green blinks (Cooling)	Red blinks	The power indicator blinks in red when the projector is on.	<ul style="list-style-type: none"> • The lamp unit cover is open. 	<ul style="list-style-type: none"> • If the power indicator blinks in red even when the lamp unit cover are securely installed, contact your nearest Sharp Authorized Projector Dealer or Service Center (see page 61) for advice.

Info

- If the temperature warning indicator illuminates, and the projector enters standby mode, follow the possible solutions above and then wait until the projector has cooled down completely before plugging in the power cord and turning the power back on. (At least 10 minutes.)
- If the power is turned off for a brief moment due to power outage or some other cause while using the projector, and the power supply recovers immediately after that, the lamp indicator will illuminate in red and the lamp may not be lit. In this case, unplug the power cord from the AC outlet, replace the power cord in the AC outlet and then turn the power on again.
- The cooling fan keeps the internal temperature of the projector constant and this function is controlled automatically. The sound of the cooling fan may change during operation because the fan speed may change and this is not a malfunction.

Regarding the Lamp

Lamp

- It is recommended that the lamp (sold separately) be replaced when the remaining lamp life becomes 5% or less, or when you notice a significant deterioration in the picture and color quality. The lamp life (percentage) can be checked with the on-screen display. (See page 47.)
- Purchase a replacement lamp of type AN-D400LP from your place of purchase, nearest Sharp Authorized Projector Dealer or Service Center.

IMPORTANT NOTE TO U.S. CUSTOMERS:

The lamp included with this projector is backed by a 90-day parts and labor limited warranty. All service of this projector under warranty, including lamp replacement, must be obtained through a Sharp Authorized Projector Dealer or Service Center. For the name of the nearest Sharp Authorized Projector Dealer or Service Center, please call toll-free: 1-888-GO-SHARP (1-888-467-4277).

Hg LAMP CONTAINS MERCURY For State Lamp Disposal Information

www.lamprecycle.org or 1-800-BE-SHARP

U.S.A ONLY

Caution Concerning the Lamp

- This projector utilizes a pressurized mercury lamp. A loud sound may indicate lamp failure. Lamp failure can be attributed to numerous sources such as: excessive shock, improper cooling, surface scratches or deterioration of the lamp due to a lapse of usage time.
The period of time up to failure largely varies depending on the individual lamp and/or the condition and the frequency of use. It is important to note that failure can often result in the bulb cracking.
- When the lamp replacement indicator and on-screen display icon are illuminated, it is recommended that the lamp be replaced with a new one immediately, even if the lamp appears to be operating normally.
- Should the lamp break, there is also a possibility that glass particles may spread inside of the projector. In such a case, it is recommended you contact your nearest Sharp Authorized Projector Dealer or Service Center to assure safe operation.
- Should the lamp break, the glass particles may spread inside the lamp cage or gas contained in the lamp may be vented into the room from the exhaust vent. Because the gas in this lamp includes mercury, ventilate the room well if the lamp breaks and avoid all exposure to the released gas. In case of exposure to the gas, consult a doctor as soon as possible.

Replacing the Lamp

Caution

- Do not remove the lamp unit from the projector right after use. The lamp will be very hot and may cause burns or injury.
- Wait at least one hour after the power cord is disconnected to allow the surface of the lamp unit to fully cool before removing the lamp unit.
- **Carefully change the lamp by following the instructions described in this section. * If you wish, you may have the lamp replaced at your nearest Sharp Authorized Projector Dealer or Service Center.**

* If the new lamp does not light after replacement, take your projector to the nearest Sharp Authorized Projector Dealer or Service Center for repair.

Regarding the Lamp (Continued)

Removing and Installing the Lamp Unit



Warning!

- Do not remove the lamp unit from the projector right after use. The lamp and parts around the lamp will be very hot and may cause burns or injury.



Info

- Do not touch the glass surface of the lamp unit or the inside of the projector.
- To avoid injury to yourself and damage to the lamp, make sure you carefully follow the steps below.
- Do not loosen other screws except for the lamp unit cover and lamp unit.

Optional
accessory

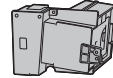

Lamp unit
AN-D400LP

- 1 Press **STANDBY/ON** on the projector or **STANDBY** on the remote control to put the projector into standby mode.**

STANDBY/ON button

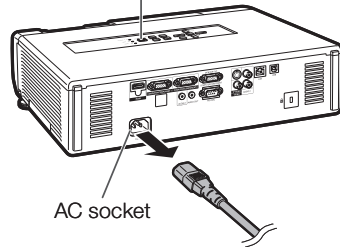

- 2 Disconnect the power cord.**
 - Unplug the power cord from the AC socket.
 - Leave the lamp until it has fully cooled down (about 1 hour).

- 3 Remove the lamp unit cover.**
 - Close the lens shutter. Loosen the user service screw (①) that secures the lamp unit cover (②).

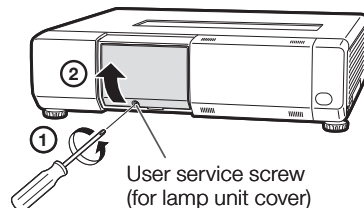
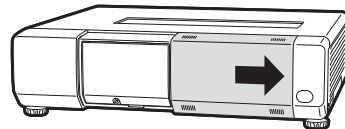

4 Remove the lamp unit.

- Loosen the securing screws from the lamp unit. Hold the lamp unit and pull it in the direction of the arrow. At this time, keep the lamp unit horizontal and do not tilt it.

5 Insert the new lamp unit.

- Press the lamp unit firmly into the lamp unit compartment. Fasten the securing screws.

6 Replace the lamp unit cover.

- Align the tab on the lamp unit cover (1) and place it while pressing the cover (2) to close it. Then tighten the user service screw (3) to secure the lamp unit cover.

Info

- If the lamp unit and lamp unit cover are not correctly installed, the power will not turn on, even if the power cord is connected to the projector.

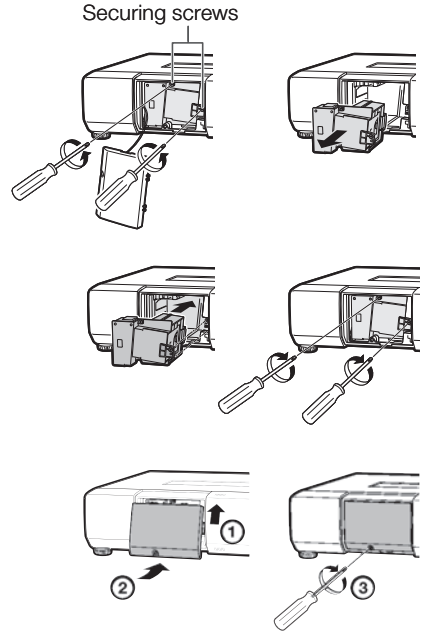

Resetting the Lamp Timer

Reset the lamp timer after replacing the lamp.

Info

- Make sure to reset the lamp timer only when replacing the lamp. If you reset the lamp timer and continue to use the same lamp, this may cause the lamp to become damaged or explode.

1 Connect the power cord and open the lens shutter fully.

- Plug the power cord into the AC socket of the projector.

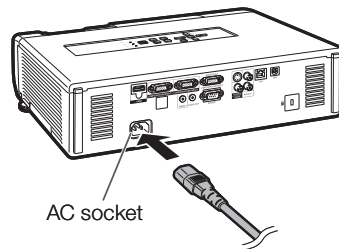

2 Reset the lamp timer.

- While simultaneously holding down **MENU/HELP**, **ENTER** and **▼** on the projector, press **STANDBY/ON** on the projector.
- “LAMP 0000H” is displayed, indicating that the lamp timer is reset.

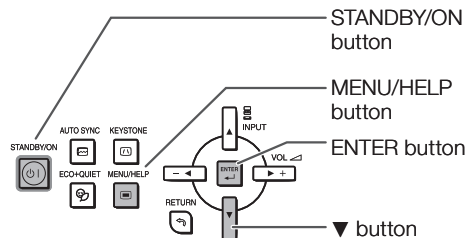

Computer Compatibility Chart

Computer

- Multiple signal support
Horizontal Frequency: 15-110 kHz,
Vertical Frequency: 45-85 Hz,
- Pixel Clock: 12-170 MHz
Sync signal: Compatible with TTL level
- Compatible with sync on green signal

PC/MAC	Mode	Resolution	Horizontal frequency [kHz]	Vertical frequency [Hz]	Analog Support	Digital Support	Display
PC	VGA	640 × 400	27.0	60	✓		Upscale
			31.5	70	✓		
			37.9	85	✓		
			27.0	60	✓		
			31.5	70	✓	✓	
		37.9	85	✓			
		26.2	50	✓			
		31.5	60	✓	✓		
		34.7	70	✓			
		37.9	72	✓			
	37.5	75	✓	✓			
	43.3	85	✓				
	31.3	50	✓				
	35.2	56	✓				
	37.9	60	✓	✓			
	48.6	70	✓				
	48.1	72	✓				
	46.9	75	✓	✓			
	53.7	85	✓				
	40.3	50	✓				
	48.4	60	✓				
	55.5	70	✓	✓			
	60.0	75	✓	✓			
	68.7	85	✓				
	45.0	60	✓	✓			
	47.8	60	✓				
	49.7	60	✓	✓			
	62.8	75	✓				
	47.7	60	✓	✓			
	47.8	60	✓	✓			
	55.9	60	✓				
	55.0	60	✓	✓			
	65.2	70	✓				
	67.5	75	✓				
	60.0	60	✓	✓			
	75.0	75	✓				
	64.0	60	✓	✓			
	80.0	75	✓				
	64.0	60	✓	✓			
	65.3	60	✓	✓			
65.3	60	✓					
75.0	60	✓					
34.9	67	✓					
49.7	75	✓					
60.2	75	✓					
MAC 13"	VGA	640 × 480	34.9	67	✓		Upscale
MAC 16"	SVGA	832 × 624	49.7	75	✓		
MAC 19"	XGA	1024 × 768	60.2	75	✓		
MAC 21"	SXGA	1152 × 870	68.7	75	✓		Intelligent Compression





Note

- Optimum image quality will be achieved by matching your computer's output resolution to the resolution that corresponds to "TRUE" in the "Display" column shown above.
- When "Screen resolution" of the computer is different from the resolution displayed on the projected image, follow the procedures shown below.
 - Refer to "Select the resolution" for "Data image is not centered" on the Help menu and select the same resolution as the resolution in "Screen resolution" of the computer.
 - Depending on the computer you are using, the output signal may not be faithful to the "Screen resolution" adjustment. Check the settings of the computer's signal output. If the settings cannot be changed, it is recommended that the resolution be set to the one that corresponds to "TRUE" in the "Display" column.

DTV

Signal	Horizontal Frequency (kHz)	Vertical Frequency (Hz)	Analog Support	Digital Support	Signal	Horizontal Frequency (kHz)	Vertical Frequency (Hz)	Analog Support	Digital Support
480I	15.7	60	✓		1080I	28.1	50	✓	✓
480P	31.5	60	✓	✓	1080I	33.8	60	✓	✓
540P	33.8	60	✓		1080P	27.0	24		✓
576I	15.6	50	✓		1080P	28.1	25		✓
576P	31.3	50	✓	✓	1080P	33.8	30		✓
720P	37.5	50	✓	✓	1080P	56.3	50	✓	✓
720P	45.0	60	✓	✓	1080P	67.5	60	✓	✓
1035I	33.8	60	✓						

Troubleshooting

Problem	Check	Page
 No picture and no sound or projector does not start.	<ul style="list-style-type: none"> • Projector power cord is not plugged into the wall outlet. 	25
	<ul style="list-style-type: none"> • Power to the external connected devices is off. 	–
	<ul style="list-style-type: none"> • The lens shutter is closed. 	26, 29
	<ul style="list-style-type: none"> • The selected input mode is wrong. 	29
	<ul style="list-style-type: none"> • Cables are incorrectly connected to the projector. 	21–25
	<ul style="list-style-type: none"> • Remote control battery has run out. 	15
 Sound is heard but no picture appears (or picture is dark).	<ul style="list-style-type: none"> • External output has not been set when connecting notebook computer. 	21
	<ul style="list-style-type: none"> • The lamp unit cover is not installed correctly. 	56, 57
	<ul style="list-style-type: none"> • Cables are incorrectly connected to the projector. • “Bright” is set to minimum position. 	21–25 41
 Color is faded or poor.	<ul style="list-style-type: none"> • Image adjustments are incorrectly set. • Make adjustments of “Color” and “Tint” in “Picture Mode” and lower the “BrilliantColor™” value. 	41
	(Video Input only) <ul style="list-style-type: none"> • Video input system is incorrectly set. 	51
 Picture is blurred; noise appears.	<ul style="list-style-type: none"> • Adjust the focus. 	27
	<ul style="list-style-type: none"> • The projection distance exceeds the focus range. 	20
	<ul style="list-style-type: none"> • There is fog on the lens. If the projector is carried from a cold room into a warm room, or if it is suddenly heated, condensation may form on the surface of the lens and the image will become blurred. Set up the projector at least one hour before it is to be used. If condensation should form, remove the power cord from the wall outlet and wait for it to clear. 	–
	(Computer Input only) <ul style="list-style-type: none"> • Perform Synchronization Adjustments (“Clock” and “Phase” Adjustment) • Noise may appear depending on the computer. 	51 –
 Picture appears but no sound is heard.	<ul style="list-style-type: none"> • Cables are incorrectly connected to the projector. 	21–25
	<ul style="list-style-type: none"> • Volume is set to minimum. • When the projector is connected to an external device and the volume is set to minimum, the sound is not output even if you turn up the volume of the external device. 	29
	<ul style="list-style-type: none"> • “Speaker” is set to “Off”. 	46
Data image is not centered.	<ul style="list-style-type: none"> • Select “Data image is not centered” in the “Help” menu and make the necessary adjustments. 	51
	<ul style="list-style-type: none"> • Depending on the computer you are using, the output resolution signal may be different from the one you have set. For details, refer to the operation manual of the computer. 	–
An unusual sound is occasionally heard from the cabinet.	<ul style="list-style-type: none"> • If the picture is normal, the sound is due to cabinet shrinkage caused by room temperature changes. This will not affect operation or performance. 	–

Troubleshooting (Continued)

Problem	Check	Page
Maintenance indicator on the projector illuminates or blinks in red.	<ul style="list-style-type: none"> • See "Maintenance Indicators". 	53
The projector cannot be turned on or put into the standby mode using STANDBY/ON on the projector.	<ul style="list-style-type: none"> • The keylock is set. • If the keylock is set to "ON", all the buttons are locked. 	48
Picture is green on COMPUTER (Component)/HDMI (Component).	<ul style="list-style-type: none"> • Change the input signal type setting. • When you cannot select an input signal type, select "Color is faded or poor" in the "Help" menu, after selecting an item other than "sRGB" in "Picture Mode", and then select an input signal type. 	51
Picture is pink (no green) on COMPUTER (RGB)/HDMI (RGB).		40, 51
Picture is too bright and whitish.	<ul style="list-style-type: none"> • Image adjustments are incorrectly set. 	41
The cooling fan becomes noisy.	<ul style="list-style-type: none"> • When temperature inside the projector increases, the cooling fan runs faster. 	8, 9 52, 53, 54
The lamp does not light up even after the projector turns on.	<ul style="list-style-type: none"> • The lamp indicator is illuminating in red. Replace the lamp. • The lens shutter is closed. 	53, 56, 57
The lamp suddenly turns off during projection.		
The image sometimes flickers.	<ul style="list-style-type: none"> • Cables are incorrectly connected to the projector or the connected equipment works improperly. • Select "Vertical stripes or flickering image appear" in the "Help" menu and make the necessary adjustments. • If this happens frequently, replace the lamp. 	21–25
		51
		56
The lamp needs much time to turn on.	<ul style="list-style-type: none"> • The lamp will eventually need to be changed. While the remaining lamp life draws to a close, replace the lamp. 	56
Picture is dark.		
One Touch Play/System Standby is not enabled.	<ul style="list-style-type: none"> • Non-Sharp Video Products are connected. One Touch Play/System Standby function may not work when the projector is connected to a non-Sharp Video Products. 	37
	<ul style="list-style-type: none"> • An HDMI cable is not used for connection between the projector and Sharp Video Products. One Touch Play/System Standby function is enabled when the projector is connected to Sharp Video Products with an HDMI cable. 	22
	<ul style="list-style-type: none"> • One Touch Play/System Standby function of the projector is not set to "On". 	37
	<ul style="list-style-type: none"> • CEC settings of connected Sharp Video Products are incorrect. 	37
The remote control cannot be used.	<ul style="list-style-type: none"> • Operate the remote control while pointing it at the projector's remote control sensor. • The remote control may be too far away from the projector. • If direct sunlight or a strong fluorescent lamp is shining on the projector's remote control sensor, place the projector where it will not be affected by strong light. 	15
	<ul style="list-style-type: none"> • The batteries may be depleted or inserted incorrectly. Make sure the batteries are inserted correctly or insert new ones. 	15

This unit is equipped with a microprocessor. Its performance could be adversely affected by incorrect operation or interference. If this should happen, unplug the Unit and plug it in again after more than 5 minutes.

For SHARP Assistance

If you encounter any problems during setup or operation of this projector, first refer to the “Troubleshooting” section on pages 59 and 60. If this operation manual does not answer your question, please contact the SHARP Service departments listed below.

U.S.A.	Sharp Electronics Corporation 1-888-GO-SHARP (1-888-467-4277) lcdsupport@sharpsec.com http://www.sharppusa.com	Benelux	SHARP Electronics Benelux BV 0900-SHARPCE (0900-7427723) Nederland 9900-0159 Belgium http://www.sharp.nl http://www.sharp.be http://www.sharp.lu
Canada	Sharp Electronics of Canada Ltd. (905) 568-7140 http://www.sharp.ca	Australia	Sharp Corporation of Australia Pty. Ltd. 1300-135-022 http://www.sharp.net.au
Mexico	Sharp Electronics Corporation Mexico Branch (525) 716-9000 http://www.sharp.com.mx	New Zealand	Sharp Corporation of New Zealand Phone: (09) 573-0111 Fax: (09) 573-0112 http://www.sharp.net.nz
Latin America	Sharp Electronics Corp. Latin American Group (305) 264-2277 www.servicio@sharpsec.com http://www.siemprisharp.com	Singapore	Sharp-Roxy Sales (S) Pte. Ltd. 65-226-6556 ckng@srs.global.sharp.co.jp http://www.sharp.com.sg
Germany	Sharp Electronics (Europe) GMBH 01805-234675 http://www.sharp.de	Hong Kong	Sharp-Roxy (HK) Ltd. (852) 2410-2623 dcmktg@srh.global.sharp.co.jp http://www.sharp.com.hk
U.K.	Sharp Electronics (U.K.) Ltd. 08705 274277 http://www.sharp.co.uk/customersupport	Taiwan	Sharp Corporation (Taiwan) 0800-025111 http://www.sharp-scot.com.tw
Italy	Sharp Electronics (Italy) S.P.A. (39) 02-89595-1 http://www.sharp.it	Malaysia	Sharp-Roxy Sales & Service Co. (60) 3-5125678
France	Sharp Electronics France 01 49 90 35 40 hotlined@sef.sharp-eu.com http://www.sharp.fr	U.A.E.	Sharp Middle East Fze 971-4-81-5311 helpdesk@smef.global.sharp.co.jp
Spain	Sharp Electronica Espana, S.A. 93 5819700 sharpd@sees.sharp-eu.com http://www.sharp.es	Thailand	Sharp Thebnakorn Co. Ltd. 02-236-0170 svc@stcl.global.sharp.co.jp http://www.sharp-th.com
Switzerland	Sharp Electronics (Schweiz) AG 0041 1 846 63 11 cattaneo@sez.sharp-eu.com http://www.sharp.ch	Korea	Sharp Electronics Incorporated of Korea (82) 2-3660-2002 lcd@sharp-korea.co.kr http://www.sharpkorea.co.kr
Sweden	Sharp Electronics (Nordic) AB (46) 8 6343600 vision.support@sen.sharp-eu.com http://www.sharp.se	India	Sharp Business Systems (India) Limited (91) 11- 6431313 service@sharp-oa.com
Austria	Sharp Electronics (Europe) GMBH Branch Office Austria 0043 1 727 19 123 pogats@sea.sharp-eu.com http://www.sharp.at		

Specifications

Model		PG-D40W3D
Display devices		0.65" DLP® Chip
Resolution		WXGA (1280 × 800)
Lens	F number	F 2.5 – 2.7
	Zoom	Manual, ×1.15 (f = 21.0 – 24.2 mm)
	Focus	Manual
Input terminals	HDMI	×1
	Computer/Component1/2 (mini D-sub 15 pin)	×2
	S-Video (mini DIN 4 pin)	×1
	Video (RCA)	×1
	Audio (ø3.5 mm stereo minijack)	×1
	Audio (RCA)	×1 (L/R)
Output terminals	Computer/Component (mini D-sub 15 pin)	×1
	Audio (ø3.5 mm stereo minijack)	×1 (variable audio output)
Control and communication terminals	LAN (RJ-45)	×1
	USB (Type B)	×1
	RS-232C (mini D-sub 9 pin)	×1
Speakers		5W × 2 (Stereo)
Projection lamp		330 W
Rated voltage		AC 100 – 240 V
Rated frequency		50/60 Hz
Input current		4.5 A
Power consumption (Standby*)		429 W (10.6 W) with AC 100 V 408 W (11.2 W) with AC 240 V
Operation temperature		41°F to 95°F (+5°C to +35°C)
Cabinet		Plastic
Dimensions (main body only) [W × H × D]		15 3/4" × 3 15/16" × 13 13/64" (400 × 100 × 335 mm)
Weight (approx.)		12.8 lbs. (5.8 kg)

*STANDBY Mode: Standard

As a part of policy of continuous improvement, SHARP reserves the right to make design and specification changes for product improvement without prior notice. The performance specification figures indicated are nominal values of production units. There may be some deviations from these values in individual units.

This SHARP projector uses a DLP® chip. This very sophisticated panel contains 1,024,000 pixels (micromirrors). As with any high technology electronic equipment such as large screen TVs, video systems and video cameras, there are certain acceptable tolerances that the equipment must conform to. This unit has some inactive pixels within acceptable tolerances which may result in inactive dots on the picture screen. This will not affect the picture quality or the life expectancy of the unit.



Dimensions

Units: inches (mm)

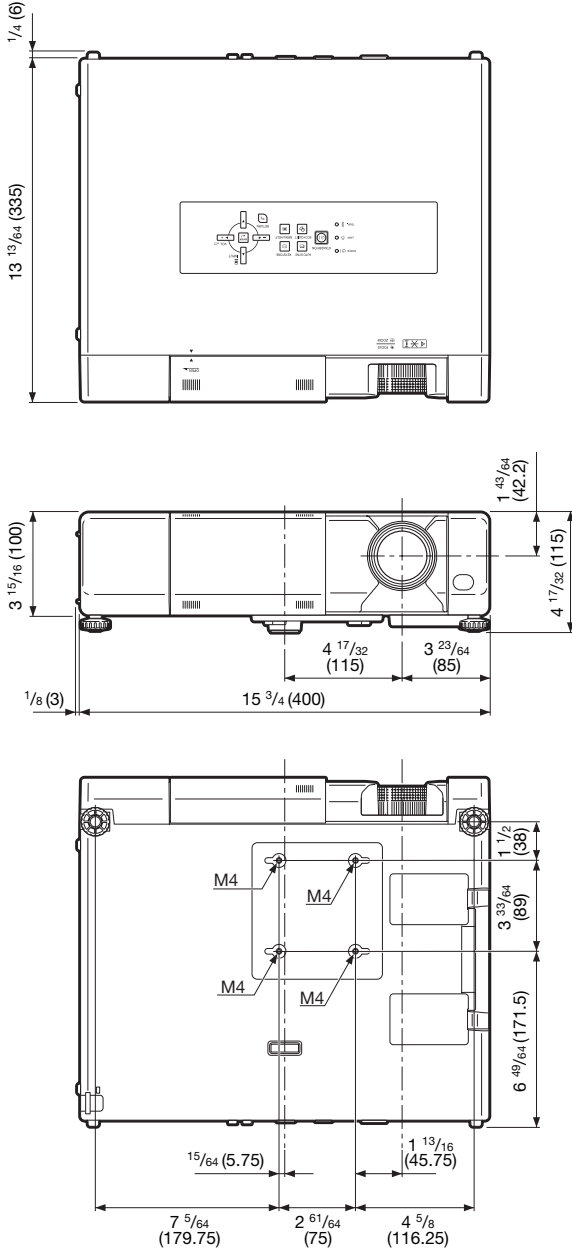

Index

3D MODE button	14	LAN terminal	25
Accessories	11	L-CLICK/EFFECT button	32, 34
AC socket	25	Lens shutter	26, 29
Adjustment buttons	38	MAC Address	50
Adjustment foot	27	MAGNIFY buttons	33
AREA ZOOM	31	MENU/HELP button	38, 51
Aspect ratio	30	MONITOR OUT terminal	23
Audio Input	46	MOUSE/Adjustment buttons	34, 38
Audio Out	46	Network	49
AUDIO 1, 2 terminal	23	NORMAL	30, 31
AUDIO OUT terminal	23	ON button	26
Auto Power Off	45	Optional accessories	11
Auto Restart	45	OSD Display	43
Auto Sync (Auto Sync adjustment)	33, 37, 45, 51	Overscan	43
AUTO SYNC button	33	PAGE DOWN button	34
AV MUTE button	29	PAGE UP button	34
Background	44	Password	49
Batteries	15	PDF	10
Blue	41	Picture Adjustment	40
BREAK TIMER button	32	Picture Mode	33, 40
Bright	41	PICTURE MODE button	33
BrilliantColor™	41	POINTER button	32
Carrying handle	13	Power cord	25
Closed Caption	44	Power indicator	53
CLR Temp (Color Temperature)	41	PRJ - ADJ	45
C.M.S.	41	PRJ Mode	19, 44
Color	41	Progressive	42
COMPUTER1/2 buttons	29	R-CLICK/RETURN button	34, 38
COMPUTER/COMPONENT1/2 input terminals	21, 22	Red	41
Contrast	41	Remote control	14
DHCP Client	50	Remote control sensor	15
DLP® Link™	44	Replacing the lamp	55, 56
DLP® Link™ Invert	44	Resize	30, 43
DNR	42	RESIZE button	30
DOT BY DOT	30	RGB cable	21
Eco+Quiet	32, 42	RS-232C terminal	24
ECO+QUIET button	32	SCR - ADJ	43
ENTER button	38	Screen Size and Projection Distance	20
Exhaust vent	12, 52	Security bar	13
Fan Mode	46	Sharp	41
Focus ring	27	Speaker	46
FREEZE button	33	SPOT button	32
FULL	30	STANDBY button	26
HDMI button	29	STANDBY Mode	45
HDMI terminal	21, 22	STANDBY/ON button	26
HEIGHT ADJUST lever	27	STRETCH	30, 31
Help	51	Supplied accessories	11
H-Pos	37, 51	S-VIDEO button	29
Image shift	43	S-VIDEO terminal	22
INPUT modes	29	System Lock	46
Intake vent	12, 52	System Sound	45
Kensington Security Standard connector	13	TCP/IP	50
Keycode	46	Temperature warning indicator	53
Keylock	48	Tint	41
KEYSTONE button	28	USB terminal	34
Keystone Correction	28, 43	VIDEO button	29
Lamp	55	Video Setup	44
Lamp indicator	53	VIDEO terminal	22
Lamp Timer (Life)	47	VOL (Volume) buttons	29
Lamp unit	56	V-Pos	37, 51
Language (on-screen display language)	44	V-STRETCH	31
		Zoom ring	27

SHARP[®]
SHARP CORPORATION